

THE INFLUENCE OF WATER AND MINERAL OIL ON MECHANICAL LOSSES IN THE DISPLACEMENT PUMP FOR OFFSHORE AND MARINE APPLICATIONS

Paweł Śliwiński

Gdańsk University of Technology, Poland

ABSTRACT

In this paper mechanical losses in a positive displacement pump supplied with water and mineral oil (two liquids having significantly different viscosity and lubricating properties) are described and compared. The experimental tests were conducted by using a prototype satellite pump of a special design. The design of the satellite pump is presented in the article. The pump features a non-circular tooth working mechanism was developed to work with both water and mineral oil. The sources of mechanical losses in such pump are also characterized in this paper. On this basis, a mathematical model of the losses has been developed and presented. The results of the calculation of mechanical losses according to the model are compared with the results of the experiment. The experimental studies have shown that the mechanical losses in the water pump are even 2.8 times greater than those in the oil pump. It has been demonstrated that the mathematical model well describes the mechanical losses both in the water pump and the oil pump. It has been found that the results from the loaded pump simulation (at $\Delta p=25\text{MPa}$) differ from the results of the experiment by no more than 5% both for oil and water.

Keywords: mechanical losses, satellite pump, water, oil

INTRODUCTION

The pump is the most important element in a hydraulic system [3-7,13,14]. Its purpose is to convert mechanical energy into hydraulic one. The energy carrier in hydraulic systems is liquid. The type of liquid is determined by the requirements for the system. The liquid commonly used in hydraulic systems is mineral oil. However, in some industrial sectors, the requirement is to apply a non-flammable (mining, steel mills, etc.) or non-toxic (food industry) liquid. In such case, non-flammable synthetic liquids, water or water-based liquids (i.e. HFA-E emulsion) are used instead of mineral oil [18,27]. Water is a liquid which is non-flammable, non-toxic

and certainly suitable for energy transfer in hydraulic systems. In comparison to mineral oil, water has a very low viscosity and low lubricating properties [10]. These parameters have a significant impact on the size of mechanical, volumetric and pressure losses in hydraulic machines [20]. The losses have an impact on the energy conversion efficiency in the machines and on the noise emission [11,15,16,18,24-26,28]. Furthermore, the design parameters of hydraulic components have an influence on energy conversion efficiency [8,9,17,21,22,27].

Generally, each hydraulic device is dedicated to a specific type of working liquid. For example, a positive displacement pump dedicated to oil systems should not be used in systems where the working medium is water.

There is a worldwide growing trend towards research and development of components and hydraulic systems supplied with water [2,3,8,9,18,27].

Studies on hydraulic systems where water is the working medium are especially important in marine technology. In offshore technology and marine applications, hydraulic power circuits are used frequently and water is generally available as a working liquid [2]. Thus, in order to eliminate the pollution of the environment, it seems reasonable and justified to eliminate oil systems and replace them with water systems. To this end, it is necessary to develop and test innovative components for hydraulic water systems [17-22]. Thus, it was reasonable to develop a new positive displacement water pump called the satellite pump and mark it with the PSM symbol. The pump contains an innovative operating mechanism consisting of non-circular gears [17,20-23]. The construction of this pump is described in the next section.

The development of the PSM pump enabled an investigation of the influence of the working liquid type (that is water and oil) on the energy losses which occur in this pump. This article is limited to the description of mechanical losses only.

The impact of the type of liquid on mechanical losses in positive displacement pumps has not yet been analyzed by other researchers. Of course, in the literature, mechanical losses have been described only for one liquid: mineral oil. Furthermore, mechanical losses have been described in general, without specifying the sources of losses [1,15,16]. Nonetheless, there is rich literature on the lubricating properties of liquids and tribological research. However, the literature concerns the basic issues only, such as the tribology of gear wheels, flat friction nodes, etc. [8-10,19]. Therefore, the influence of the type of liquid on mechanical losses in a positive displacement pump is a new issue, it is cognitive and represents an important scientific problem. Consequently, the following objectives have been defined for this article:

- indicate and describe sources of mechanical losses in the satellite pump;
- describe a mathematical model of mechanical losses;
- compare mechanical losses in the oil pump to those in the water pump;
- compare the results of experimental research with a mathematical model.

SATELLITE PUMP

The experimental research on the influence of the type of liquid on volumetric losses was carried out by using a prototype of a positive displacement pump developed by this author. For experimental tests, a prototype of a satellite pump was selected and marked with the symbol PSM-0,75/15 (Fig. 1). The design of this pump is presented in Fig. 2. The working mechanism of the satellite pump is a specific gear mechanism in which the rotor rotates around the shaft axis and the revolving motion is done by satellites which are in gear with the stator and the rotor (Fig. 3).



Fig. 1. General view of PSM-0,75 pump

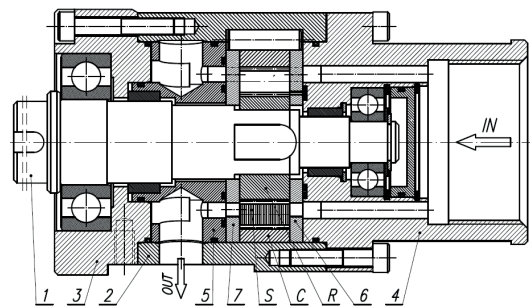

Fig. 2. Axial cross section of the novel PSM-0,75 pump:
C - curvature, S - satellite, R - rotor, 1 - shaft, 2 - casing,
3 - front casing, 4 - rear casing (suction manifold), 5 - pressure manifold,
6 and 7 - compensation (commutation) plates

The toothed unit shown in Fig. 3, is the satellite working mechanism of the pump. It consists of a toothed rotor R (4 humps), toothed curvature C (6 humps) and ten wheels S (satellite).

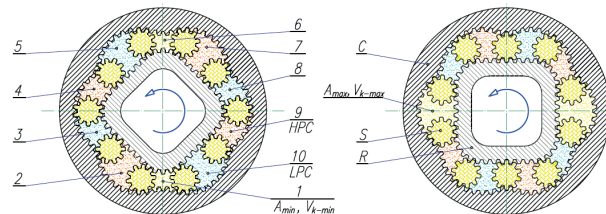

Fig. 3. The working mechanism of a satellite pump:
C - curvature, R - rotor, S - satellite, 1+10 - working chambers, LPC - low pressure working chamber, HPC - high pressure working chamber,
 V_{k-min} - working chamber with the minimum area A_{min} (dead chamber),
 V_{k-max} - working chamber with the maximum area A_{max} [17,19-23]

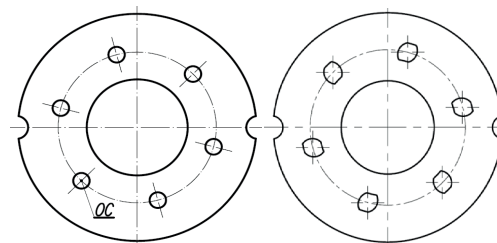

Fig. 4. High pressure commutation plate (left) and suction commutation plate (right) [17,20,22]

The principle of operation of the satellite mechanism is that when the rotor rotates, the volume of the space

between the satellites changes. This space forms the working chamber. When its volume increases, the filling cycle takes place. Conversely, when its volume decreases, the emptying cycle occurs. Twenty-four cycles correspond to one shaft revolution. The chambers in the satellite mechanism are closed by commutation plates (Fig. 2 – elements 6 and 7, Fig. 4), which also play the role of compensation plates. Thus, the satellite pump has the ability to compensate axial clearances of the rotor and the satellites [17,19-23].

Experimental studies of the PSM-0,75/15 pump were carried out by using the following liquids:

- the Total Azolla 46 oil ($\nu=40\text{cSt}$, $\rho=873\text{kg/m}^3$, $\mu=35\text{mPas}$);
- tap water ($\nu=0,853\text{cSt}$, $\rho=996\text{kg/m}^3$).

The tested pump was characterized by the following parameters:

- theoretical displacement $q_t=18,63\text{ cm}^3/\text{rev}$;
- teeth module $m=0,75\text{mm}$;
- height of working mechanism $H=15\text{mm}$.

TEST STAND

The PSM pump was tested on the test stand with power recuperation. The diagram of the measurement system of the test stand is shown in Fig. 5.

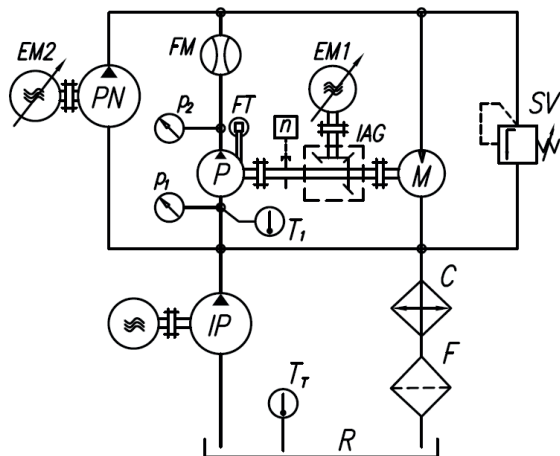

Fig. 4. The diagram of the measurement system of the test stand: P – tested pump, M – hydraulic motor, PN – pump for filling the leaks in P and M, IP – impeller pump (pre-supply pump), SV – safety valve, C – cooler, F – filter, R – reservoir, IAG – intersecting axis gear, EM1 and EM2 – electric motors with frequency converters, other designations – see description in the text below

During the test of the pump the following parameters were measured:

- pressure p_1 in suction port (strain gauge pressure transducer, range: $-1\div+3\text{ bar}$, class 0,3);
- the pressure p_2 in pumping port (strain gauge pressure transducers, range: $0\div25\text{ bars}$ and $0\div250\text{ bars}$, class 0,3);
- the pump delivery Q (mass flow meter FM, range: $0\div33\text{ l/min}$, class 0,1);
- the torque M (strain gauge force transducer FT mounted on the arm of 0,5m (arm attached to the pump body), range: $0\div100\text{N}$, class 0,1);

- the rotational speed of shaft n [rpm] (inductive sensor, measurement accuracy: $\pm 1\text{rpm}$);
- the temperature T_1 of liquid in the suction port of the pump (RTD temperature sensor, class A, max. measurement error: $0,5^\circ\text{C}$).

PRESSURE DROP IN INTERNAL CHANNELS

The pressure losses in the pump are a combination of the pressure drop in the internal channels and the pressure drop in the commutation unit.

The volumetric losses depend on the pressure increase in the working chambers of the pump. This pressure is difficult to measure. On the other hand, it is easy to measure the pressure increase Δp in the pump ports. The relationship between Δp and Δp_i is as follows:

$$\Delta p_i = \Delta p - \Delta p_{ich} \quad (1)$$

where Δp_{ich} is the pressure drop in internal channels of the pump. The methodology of measuring Δp_{ich} is described in [21].

The internal channels have a complicated geometry. The non-fully developed turbulent flow takes place in the channels. Therefore, to describe Δp_{ich} , it is proposed to adopt the following simplified relationship [21]:

$$\Delta p_{ich} = C_t \cdot \rho \cdot Q^2 + C_l \cdot \mu \cdot Q \quad (2)$$

where C_l and C_t are coefficients mainly dependent on the geometrical dimensions of the internal channel. The values of the coefficients (for Δp in [MPa], Q in [l/min], μ in [mPas] and ρ in [kg/m^3]), calculated on the basis of the experimental results, are as follows:

- for oil: $C_t = 0,282 \cdot 10^{-7}$ and $C_l = 0,583 \cdot 10^{-5}$.
- for water: $C_t = 0,146 \cdot 10^{-7}$ and $C_l = 0,343 \cdot 10^{-3}$.

The characteristics of $\Delta p_{ich}=f(Q)$ in a pump pumping oil and water, calculated according to formula (3), are shown in Fig. 6.

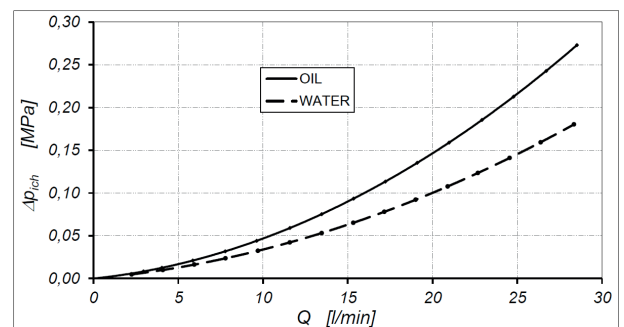

Fig. 6. Characteristics of $\Delta p_{ich}=f(Q)$ for oil and water – result of calculation acc. Eq. (2)

SOURCES OF MECHANICAL LOSSES

Mechanical losses in a satellite pump result from:

- rolling and sliding friction between the gear mechanism elements;
- compression of liquid in the death volumes V_{k-min} of the satellite working mechanism (Fig. 3);
- compression of liquid in the space between the teeth of the working mechanism elements (Fig. 7);
- the inertia of the working mechanism elements and the inertia of liquid in working chambers;
- friction in the bearings and seals;
- viscous friction in the gaps between all moving parts of the pump.

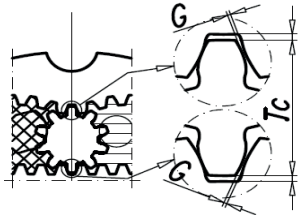

Fig. 7. Tip clearance T_c and backlash G [19,21]

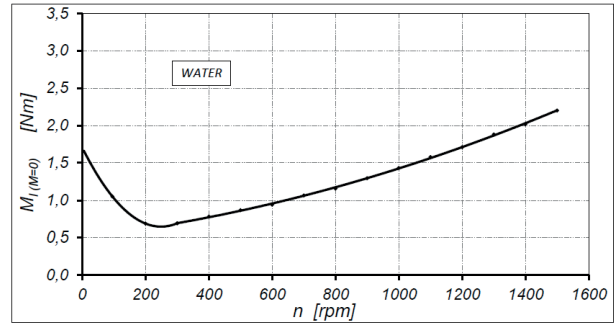

Fig. 9. Characteristics of $M_{l(M=0)} = f(n)$ in unloaded pump. Working medium: water

COMPONENTS OF MECHANICAL LOSSES IN AN UNLOADED PUMP

An analysis of experimental results indicates a non-linear relationship $M_{l(M=0)} = f(n)$ (Fig. 8 and Fig. 9). Mechanical losses $M_{l(M=0)}$ in an unloaded pump can be expressed as the sum of components:

$$M_{l(M=0)} = M_{bs} + M_{id} + M_{dc} + M_{ts} + M_v + \Delta M_{lm(M=0)} \quad (4)$$

where:

- M_{bs} – the torque of losses in the bearings and seals;
- M_{id} – the torque of losses dependent on the inertia of the working mechanism elements and the inertia of liquid in the working chambers;
- M_{dc} – the torque of losses caused by compression of liquid in death volumes;
- M_{ts} – the torque of losses caused by compression of liquid in the spaces between the teeth;
- M_v – the torque of losses caused by viscous friction in the clearances of the working mechanism;
- $M_{lm(M=0)}$ – the torque of losses at low speed. This loss component reaches its maximum value for a speed close to zero.

TORQUE OF LOSSES IN BEARINGS AND SEALS

The results of experimental studies on seals used in hydraulic machines show that the torque of friction in seal to the greatest extent depends on the pressure of the liquid contained in the seal chamber. The rotational speed of the shaft has a much smaller effect on M_s . In addition, M_s depends on the working fluid (lubricating properties) [19,21]. In a satellite pump, the rubbing speed of seals relative to the shaft neck exceeds 2 m/s. Additionally, the fluid pressure in the seal chamber is strictly dependent on the pressure in the suction port (leaks from the working mechanism are discharged into the chamber of the shaft to the suction port). During the pump tests, the pressure in the suction port was $p_1 = <0,1 \text{ MPa}$.

The results of the seal tests have shown that the torque of friction in the seals (at the shaft speed of 1500 rpm) does not exceed $M_b = 0,8 \text{ Nm}$ in the oil pump and $M_b = 0,9 \text{ Nm}$ in the water pump.

TORQUE OF LOSSES IN UNLOADED PUMP

RESULTS OF EXPERIMENT

There are two experimental methods of measuring the torque of losses $M_{l(\Delta p=0)}$ in an unloaded pump ($\Delta p=0$):

- by measuring the torque on the shaft of the pump. It is then necessary to eliminate the torque corresponding to the pressure drop in the suction pipe and the outflow pipe;
- by measuring the pressure drop in the pump working as a motor (the pump is supplied with liquid and the shaft is uncoupled) [21].

In the tested pump $M_{l(\Delta p=0)}$ was determined according to the second method. Hence, it can be assumed that $M_{l(\Delta p=0)} = M_{l(M=0)}$. $M_{l(M=0)}$ was calculated from the relationship:

$$M_{l(M=0)} = \frac{q \cdot \Delta p_i}{2 \cdot \pi} \quad (3)$$

The experimentally determined characteristics of mechanical losses $M_{l(M=0)}$ in an unloaded pump are shown in Fig. 8 and in Fig. 9.

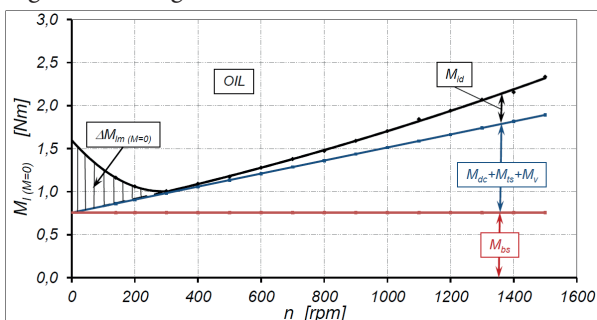

Fig. 8. Characteristics of $M_{l(M=0)} = f(n)$ in unloaded pump. Working medium: oil

However, for simplicity, the model assumes that the torque of friction in the seals is a function of the pressure in the seal chamber and does not depend on the rotational speed.

Bearings in satellite machines have no contact with the working liquid. Hence, the torque of losses in bearings M_b does not depend on the liquid lubricant type. Furthermore, for simplicity, it is assumed that the friction in the bearings is independent from the shaft speed. The pump working mechanism is hydrostatically balanced. Therefore, the load Δp of the pump has no influence on the torque of losses in the bearings.

Thus, the torque of losses in the bearings and seals of the satellite pump can be described by the equation:

$$M_{bs} = M_b + M_s = M_b + C_s \cdot p_2 \cong C_{bs} \cdot p_2 \quad (5)$$

in which $C_s \left[\frac{Nm}{MPa} \right]$ and $C_{bs} \left[\frac{Nm}{MPa} \right]$ are constants. The value of the constant C_{bs} is shown in Tab. 1.

TORQUE OF LOSSES DEPENDENT ON INERTIA OF SATELLITES AND INERTIA OF LIQUID IN WORKING CHAMBERS

During the operation of a satellite mechanism, the satellites are moving with a variable plane motion – there is a cyclic variation in the speed of each satellite. Mechanical energy is supplied to the satellite during acceleration. Later, during deceleration, the energy is returned. The difference between the delivered and returned energy is the energy consumed in the process of friction. Similarly, during the operation of a satellite mechanism, there is acceleration and deceleration of the liquid in the working chambers. Thus, the energy lost depends on the inertia of the liquid and the satellites. During the commutation change (e.g. at the time of the opening of the inflow channel and cutting off the outflow channel by a satellite), inertial forces resist changes in the position of the satellite teeth in the space between the rotor teeth and the curvature. The inertia force of the satellite depends on its mass and hence the module m of the teeth, the height H of the satellites and the density of the material from which these components are made. Similarly, the inertia of the liquid depends on its density and the working chamber volume.

The torque of losses M_{id} dependent on the inertia of satellites and inertia of liquid in working chambers can be described with the equation:

$$M_{id} = C_{id} \cdot m^4 \cdot H \cdot n^2 \quad (6)$$

where $C_{id} \left[\frac{Nm}{rpm^2 mm^5} \right]$ is a constant depending on the type of the satellite material and the type of liquid.

At the current stage, no experimental studies have been carried out to determine the influence of:

- the inertia of satellites;
- liquid parameters (density and viscosity);
- backlash of satellites in working mechanism on the value of the constant C_{di} .

It can be assumed that for oil the value of C_{di} will be smaller than for water because the density of oil is smaller than the density of water.

TORQUE OF LOSSES CAUSED BY VISCOUS FRICTION IN GAPS AND BY COMPRESSION OF THE LIQUID IN DEATH VOLUMES AND SPACES BETWEEN TEETH

The process of compressing the liquid in the death volumes of the working mechanism occurs when the mechanism rotates and there is no flow from the death volume to both the outflow channel and the inflow channel.

During the motor shaft rotation, the walls of gaps of the working mechanism move relative to each other. This causes the drift of the liquid layers in the gaps. Viscous friction in the liquid in the gaps can be expressed as the torque of losses M_v . The torque is proportional to the relative speed of the gap walls and the viscosity of liquid [1]. Thus:

$$M_v = C_v \cdot \mu \cdot n \quad (7)$$

where $C_v \left[\frac{Nm}{mPas \cdot rpm} \right]$ is the constant.

The M_v component reaches very small values, it is very difficult to determine and hence very often neglected ($M_v=0$) [1]. Furthermore, the M_{dc} and M_{ts} components are impossible to determine. Therefore it is proposed to introduce a replacement component M_{dsv} of the torque of losses, which is expressed by the empirical formula:

$$M_{dsv} = M_{dc} + M_{ts} + M_v = C_{dsv} \cdot m^4 \cdot H^2 \cdot n \quad (8)$$

where $C_{dsv} \left[\frac{Nm}{mm^6 \cdot rpm} \right]$ is the constant.

TORQUE OF LOSSES AT LOW SPEED

Pumps do not work at low speeds. Hence, the component of torque of losses $M_{lm(M=0)}$ occurring at low speeds, i.e. speed in the range from a value close to 0 ($n=0^+$) to a certain limit speed n' can be eliminated from consideration.

TORQUE OF LOSSES IN UNLOADED PUMP

After inserting (5), (6) and (8) to (4), the following equation is obtained:

$$M_{l(M=0)} = C_{id} \cdot m^4 \cdot H \cdot n^2 + C_{dsv} \cdot m^4 \cdot H^2 \cdot n + C_{bs} \cdot p_2 \quad (9)$$

Hence, the equation describing the torque of losses in the unloaded pump is a square equation. The values of coefficients C_{id} and C_{dsv} can be calculated from the equation of the trend line (Fig. 8 and Fig. 9). The values C_{id} and C_{dsv} are shown in Tab. 1.

TORQUE OF LOSSES IN LOADED PUMP

RESULTS OF EXPERIMENT

The mechanical losses M_l in a loaded pump was calculated according to the formula:

$$M_l = \frac{q \cdot \Delta p_i}{2 \cdot \pi} - M \quad (10)$$

The experimentally determined characteristics of the mechanical losses M_l in function of Δp_i , and the rotational speed n of the pump shaft are shown in Fig. 10÷13.

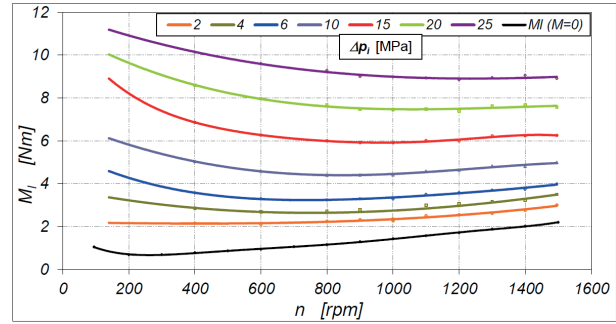

Fig. 13. Characteristics of $M_l=f(n)$. Working medium: water

COMPONENTS OF MECHANICAL LOSSES IN A LOADED PUMP

The torque of mechanical losses M_l in a loaded pump is the following sum:

$$M_l = \underbrace{M_{bs} + M_{id} + M_{dsv}}_{M_l(M=0)} + \underbrace{\Delta M_{lm} + M_{lm}}_{M_{mf}} \quad (11)$$

where:

- M_{lm} – the torque of losses caused by mixed friction (depending on the increase in pressure Δp_i in the working chambers of the pump). The torque M_{lm} is calculated on the basis of experimental data as:

$$M_{lm} = M_l - M_l(M=0) \quad (12)$$

assuming that $\Delta M_{lm} = 0$;

- ΔM_{lm} – the torque of losses in a loaded pump occurring at low speeds and reaching the maximum value for a speed close to 0. Due to the fact that the pumps never operate at low speeds, this component can be skipped in the consideration, that is $\Delta M_{lm} = 0$.

TORQUE OF LOSSES M_{mf}

The experimentally determined characteristics of $M_{mf}=f(\Delta p_i)_{n=const}$ and $M_{mf}=f(n)_{\Delta p_i=const}$, for $M_{lm}=0$, are shown in Fig. 14÷16.

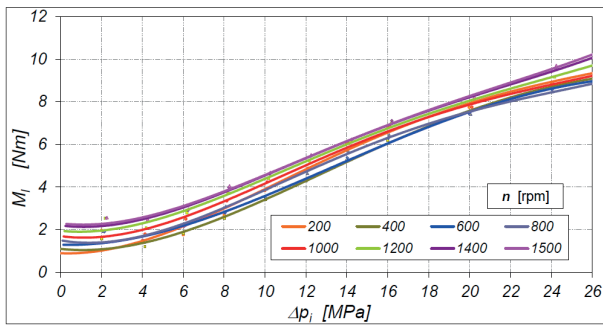

Fig. 10. Characteristics of $M_l=f(\Delta p_i)$. Working medium: oil

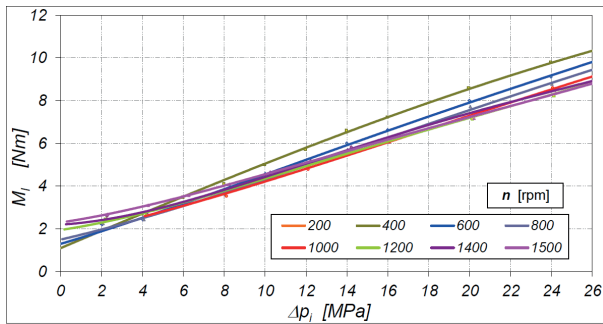

Fig. 11. Characteristics of $M_l=f(\Delta p_i)$. Working medium: water

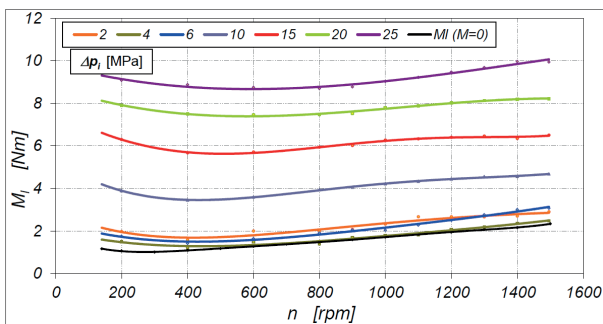

Fig. 12. Characteristics of $M_l=f(n)$. Working medium: oil

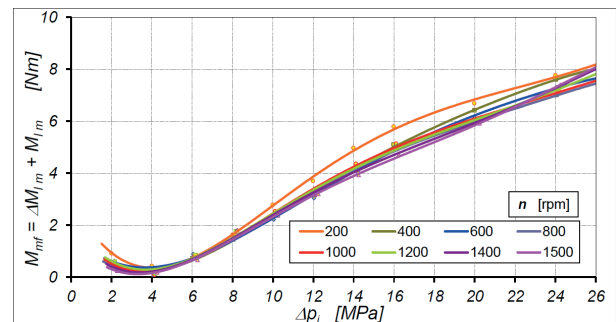

Fig. 14. Characteristics of $M_{mf}=f(\Delta p_i)$. Working medium: oil

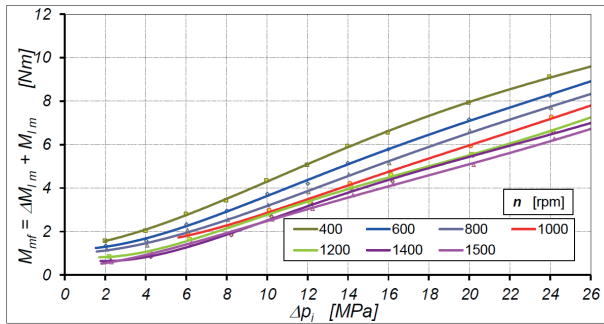

Fig. 15. Characteristics of $M_{lm} = f(\Delta p_i)$. Working medium: water

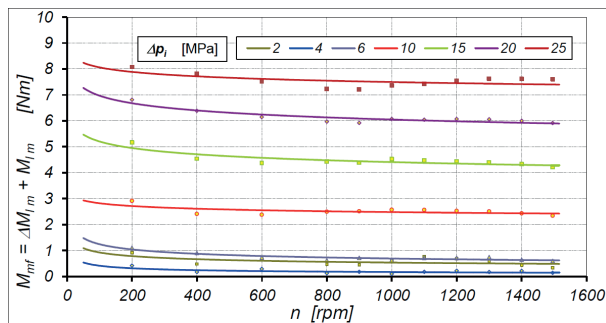

Fig. 16. Characteristics of $M_{lm} = f(n)$. Working medium: oil

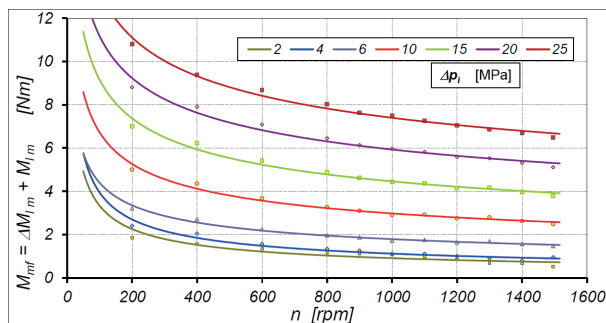

Fig. 17. Characteristics of $M_{lm} = f(n)$. Working medium: water

According to the characteristics (Fig. 17÷17) M_{mf} varies throughout the range of speed n and increases nonlinearly (disproportionately) with increasing the load Δp_i .

According to Niemann [12], the mean friction coefficient in the gear teeth can be described by the equation:

$$f = 0,048 \left(\frac{F}{b \cdot v \cdot \rho} \right)^{0,2} \mu^{-0,05} R_a^{0,25} \left(\frac{F}{b} \right)^{-0,065} \quad (13)$$

where:

- F [N] – the circumferential force on the rolling circle;
- b [mm] – the width of the gear wheel;
- μ [mPas] – the dynamic viscosity of the liquid;
- v [m/s] – the summary speed of the cooperating wheels;
- ρ [mm] – the replacement radius of the tooth profile at the pitch point;
- R_a [μ m] – the mean surface roughness of the side gear of interacting teeth.

In the above equation, there is no compatibility between the units of measurement. Thus, it is supposed that the above equation is purely hypothetical (or empirical).

In satellite machines:

- the radius ρ of the curvature of the teeth is dependent upon the module m of the teeth;
- the width b of the teeth is tantamount to the height H of the satellite mechanism;
- the pitch diameter D_p is a function of the teeth module m ;
- the summary speed v of the cooperating wheels depends on the rotor (or shaft) rotational speed and the size of the mechanism (and the size of the teeth module m).

Taking into account the above-mentioned dependence, it is proposed to describe the torque of losses M_{mf} in the satellite mechanism by the empirical relationship:

$$M_{mf} \approx M_{lm} = C_{lm} R_a^\gamma (\mu H m^3)^{-\gamma} M^\alpha n^{-\beta} \quad (14)$$

where C_{lm} is the coefficient.

The load of the pump is a parameter independent of the pump. Hence, M_{lm} should be written as a function of Δp_i . Then:

$$M_{mf} = C_{lm} R_a^\gamma (\mu H m^3)^{-\gamma} \left(\frac{q \cdot \Delta p_i}{2 \cdot \pi} \right)^\alpha n^{-\beta} \quad (15)$$

The coefficient α was read directly from the equation of the trend line of the characteristics shown in Fig. 14 and in Fig. 15. There was no correlation between the value of the coefficient α and the speed n of the pump. Therefore, it was assumed that coefficient α does not depend on n . Thus, the value of this coefficient is calculated as the arithmetic average of the obtained results. The values of α are shown in Tab.1.

The coefficient β can be read from the equation of the trend line of the characteristics shown in Fig. 16 and in Fig. 17. The value of this coefficient varies nonlinearly in function of the pressure increase Δp_i in the pump working chambers (Fig. 18).

γ

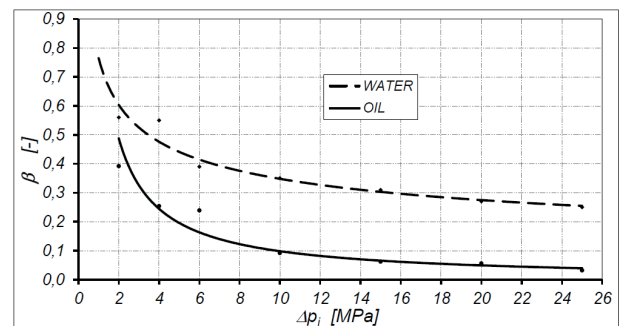

Fig. 18. Characteristics of $\beta = f(\Delta p_i)$. Working medium: oil and water

The factor β can be described as an empirical formula:

$$\beta = a \cdot \Delta p_i^{-b} \quad (16)$$

where a and b are coefficients. The values of a and b are shown in Tab. 1.

The coefficients γ and C_{lm} were so selected as to obtain the best fit of a curve to the results of the experiment. It should be added that $R_a = 0,1 \mu m$ in the satellite mechanism. The values of γ and C_{lm} are shown in Tab. 1.

Tab. 1. Values of the coefficients in model of mechanical losses

	C_{bs}	C_{id}	C_{dsv}	C_{lm}
	$\left[\frac{Nm}{MPa} \right]$	$\left[\frac{Nm}{mm^5 rpm^2} \right]$	$\left[\frac{Nm}{mm^6 rpm} \right]$	$[-]$
Oil	8,0	$40,1 \cdot 10^{-9}$	$10,6 \cdot 10^{-6}$	0,21
Water	9,0	$49,6 \cdot 10^{-9}$	$16,6 \cdot 10^{-6}$	1,23
	•	•	a	b
	$[-]$	$[-]$	$[-]$	$[-]$
Oil	1,35	0,2	0,955	1
Water	1,32	0,2	0,765	0,342

The characteristics of $M_{mf} = f(\Delta p_i)$ and $M_{mf} = f(n)$ plotted according to the formula (15) and Tab.1 are shown in Fig. 19÷22.

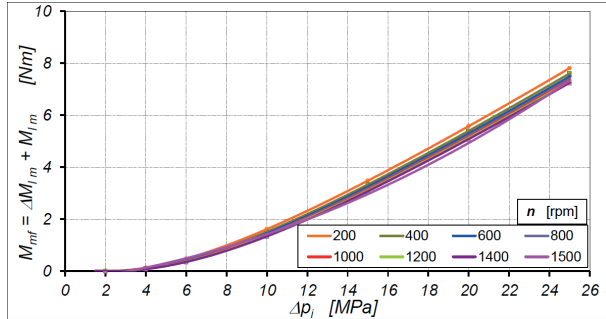

Fig. 19. Characteristics of $M_{mf} = f(\Delta p_i)$ – result of calculation acc. Eq. (15). Working medium: oil

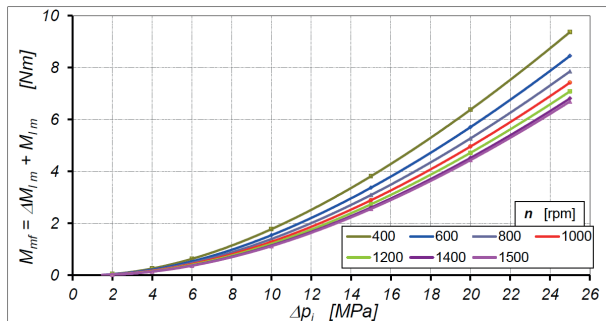

Fig. 20. Characteristics of $M_{mf} = f(\Delta p_i)$ – result of calculation acc. Eq.(15). Working medium: water

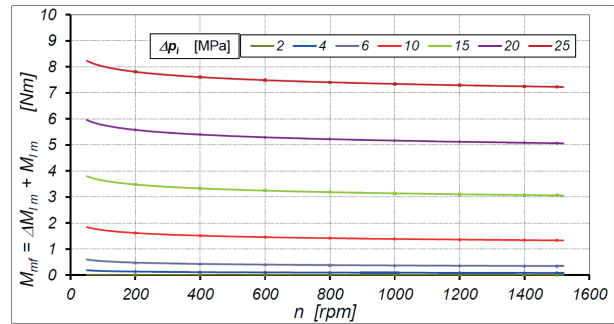

Fig. 21. Characteristics of $M_{lm} = f(n)$ – result of calculation acc. Eq. (15). Working medium: oil

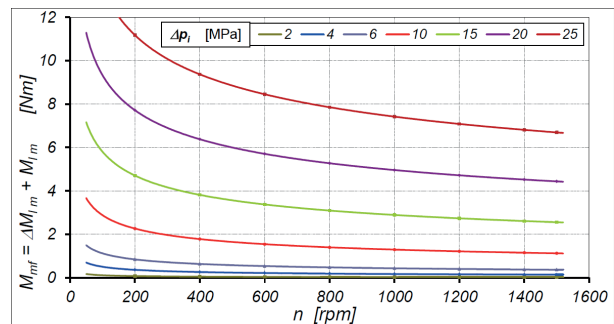

Fig. 22. Characteristics of $M_{lm} = f(n)$ – result of calculation acc. Eq.(15). Working medium: water

TORQUE OF LOSSES IN LOADED PUMP

The torque of losses M_l in a pump, expressed by formula (11), when written in the expanded form, looks as follows:

$$M_l = C_{id} m^4 H n^2 + C_{dsv} m^4 H^2 n + C_{lm} (\mu H m^3 n)^{-\beta} \left(\frac{q \Delta p_i}{2\pi} \right)^\alpha + C_{bs} p_2 \quad (17)$$

The characteristics of $M_l = f(\Delta p_i)$ and $M_l = f(n)$, plotted according to the formula (17), are shown in Fig. 23÷26.

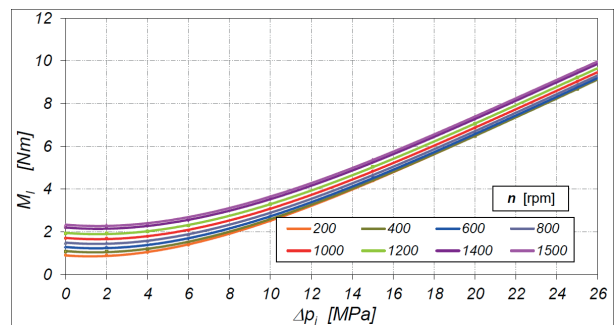

Fig. 23. Characteristics $M_l = f(\Delta p_i)$ – result of calculation acc. Eq.(17). Working medium: oil

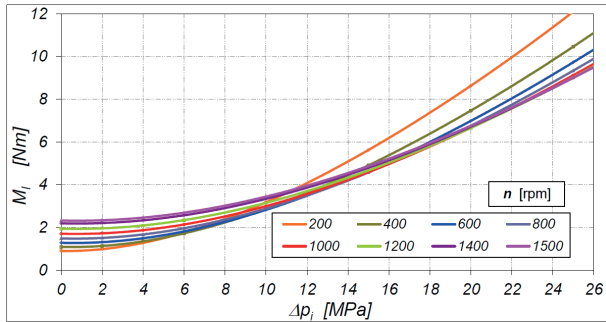

Fig. 24. Characteristics $M_l=f(\Delta p_i)$ – result of calculation acc. Eq. (17). Working medium: water

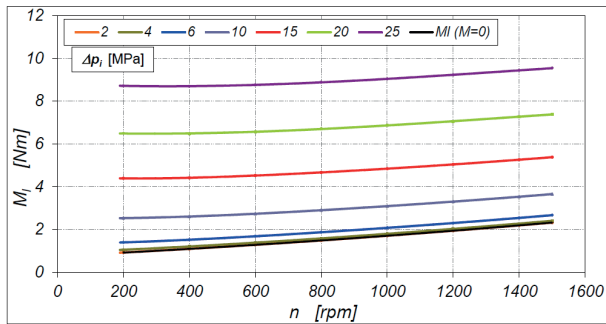

Fig. 25. Characteristics $M_l=f(n)$ – result of calculation acc. Eq.(17). Working medium: oil

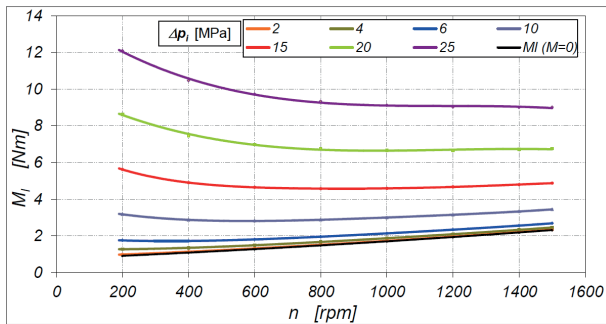

Fig. 26. Characteristics $M_l=f(n)$ – result of calculation acc. Eq.(17). Working medium: water

MECHANICAL LOSSES RATIO

The research results prove that the mechanical losses in the water pump are greater than those in the oil pump. The biggest difference is observed in the pump working at a low speed and low load. Furthermore, the ratio of the losses decreases with increasing Δp (Fig. 27).

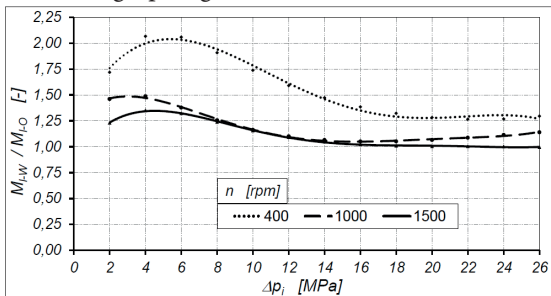

Fig. 27. Characteristics of the mechanical losses ratio $M_{l,w}/M_{l,o}=f(\Delta p)$

ERROR IN MECHANICAL LOSSES CALCULATION

The values of mechanical losses M_l in the oil pump and in the water pump, calculated according to (17), are different from the values determined experimentally.

The differences are defined as follows:

$$\delta M_l = \frac{M_l - M_{l-sym}}{M_l} \cdot 100\% \quad (18)$$

The characteristics of $\delta M_l=f(\Delta p_i)$ are shown in Fig. 28 and 29.

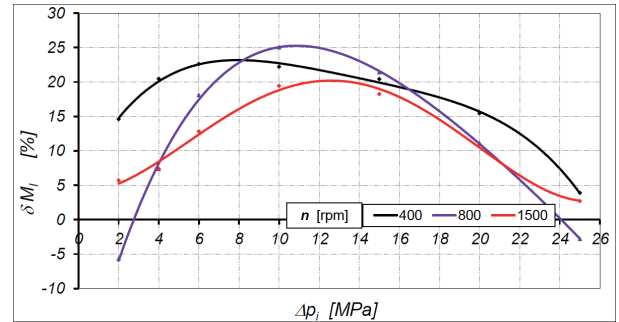

Fig. 28. Characteristics of $\delta M_l=f(\Delta p_i)$. Working medium: oil

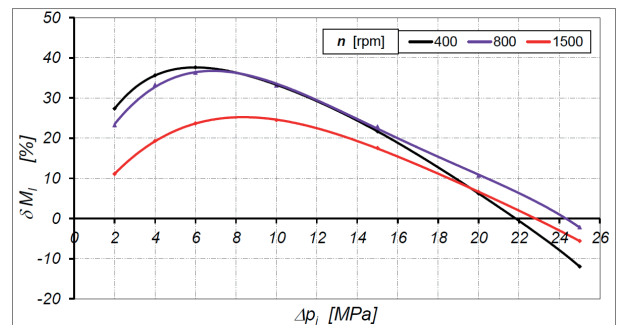

Fig. 29. Characteristics of $\delta M_l=f(\Delta p_i)$. Working medium: water

From the above presented characteristics it can be concluded that the proposed mathematical model describes quite accurately the torque of losses in the pump supplied with both mineral oil and water. Therefore, mechanical losses in the pump working with various liquids can be assessed by comparing the model coefficients.

SUMMARY

The article presents the results of experimental research on mechanical losses in the novel satellite pump, for which the working medium was water and mineral oil. The experimental studies have shown that the type of liquid has an impact on the values of losses. The mechanical losses are bigger in a water pump than in an oil pump – especially at low values of the load Δp and speed n .

Experimental studies have shown that the greatest source of mechanical losses in the pump is friction in the working

mechanism. Much smaller mechanical losses occur in the bearings and seals, and the type of liquid has the least impact on the mechanical losses in these elements. The smallest component of the mechanical losses is that depending on the liquid viscosity, i.e. the mechanical losses caused by viscous friction in gaps.

The mathematical model of the torque of mechanical losses described in the article has been developed based on an analysis of the sources of the losses. The coefficients in the mathematical model were calculated on the basis of the experimental data and plotted characteristics of losses in the oil pump and water pump. The described mathematical model will provide a more accurate simulation of the characteristics of mechanical losses in a satellite pump.

BIBLIOGRAPHY

1. Balawender A.: Physical and mathematical model of losses in hydraulic motors. Developments in mechanical engineering, Gdansk University of Technology Publishers. Gdansk 2005
2. Dymarski C., Dymarski P.: Developing Methodology for Model Tests of Floating Platforms in Low-Depth Towing Tank. Archives of Civil and Mechanical Engineering, No. 1/2016, DOI: dx.doi.org/10.1016/j.acme.2015.07.003
3. Guzowski A., Sobczyk A.: Reconstruction of hydrostatic drive and control system dedicated for small mobile platform. American Society of Mechanical Engineers, 2014. DOI: dx.doi.org/10.1115/FPNI2014-7862.
4. Jasinski R.: Influence of design of hydraulic components on their operation in low ambient temperatures. Key Engineering Materials, Vol. 490, 2012. DOI:10.4028/www.scientific.net/KEM.490.106.
5. Jasiński R.: Influence of type of material on performance of hydraulic components in thermal shock conditions. Solid State Phenomena, Vol. 183, 2012. DOI: 10.4028/www.scientific.net/SSP.183.95.
6. Jasinski R.: Problems of the starting and operating of hydraulic components and systems in low ambient temperature (Part IV). Modelling the heating process and determining the serviceability of hydraulic components during the starting-up in low ambient temperature. Polish Maritime Research, No 3 (95) 2017. DOI: 10.1515/pomr-2017-0089
7. Kollek W., Osinski P., Warzynska U.: The influence of gear micro-pump body asymmetry on stress distribution. Polish Maritime Research, No 1/2017. DOI: https://doi.org/10.1515/pomr-2017-0007
8. Litwin W., Dymarski C.: Experimental research on water lubricated marine stern tube bearings in conditions of improper lubrication and cooling causing rapid bush wear. Tribology International Vol. 95 (2016). DOI: 10.1016/j.triboint.2015.12.005
9. Litwin W., Olszewski A.: Water-Lubricated Sintered Bronze. Journal Bearings - Theoretical and Experimental Research. Tribology Transactions, vol. 57, No. 1/2014. DOI: 10.1080/10402004.2013.856980
10. Lubinski J., Sliwinski P.: Multi parameter sliding test result evaluation for the selection of material pair for wear resistant components of a hydraulic motor dedicated for use with environmentally friendly working fluids. Solid State Phenomena, No 225/2015.
11. Maczyszyn A.: Investigation method and mathematical model of pressure losses in hydraulic rotary motor. Polish Maritime Research, No. 97/2018 Vol. 25. DOI: 10.2478/pomr-2018-0011
12. Niemann G., Winter H.. Maschinenelemente – Band 2 (in German) , Springer-Verlag, Berlin, 2003.
13. Osinski P., Chruscielski G.: Strength calculations of an element compensating circumferential backlash in the external gear pump. Journal of Theoretical and Applied Mechanics. Vol. 54, No. 1/2016. DOI: 10.15632/jtam-pl.54.1.251
14. Osinski P., Deptula A., Partyka M.: Discrete optimization of a gear pump after tooth root undercutting by means of multi-valued logic trees. Archives of Civil and Mechanical Engineering, No. 4/2013, DOI: 10.1016/j.acme.2013.05.001.
15. Paszota Z.: Energy losses in hydrostatic drive. LABERT Academic Publishing, 2016.
16. Paszota Z.: Theoretical models of the torque of mechanical losses in the pump used in a hydrostatic drive. Polish Maritime Research, No. 4/2011.
17. Patrosz P.: Deformation in the axial clearance compensation node in the satellite pump unit. Hydraulika i Pneumatyka 1/2014
18. Pobedza J., Sobczyk A.: Properties of high pressure water hydraulic components with modern coatings. Advanced Materials Research. Trans Tech Publications Ltd, 849/2014. DOI: 10.4028/www.scientific.net/AMR.849.100.
19. Sliwinski P.: High pressure rotational seals for shaft of hydraulic displacement machines. Hydraulics and Pneumatics, 3/2014, Poland.
20. Sliwinski P.: New satellite pumps. Key Engineering Materials, No 490/2012.

21. Sliwinski P.: Pressure losses and power balance in the unloaded satellite pump. *Hydraulika a Pneumatika*, No 1-2/2013, Slovakia
22. Sliwinski P.: Satellite pumps. *Hydraulika i Pneumatyka*, No. 5/2012, Poland
23. Sliwinski P.: The flow of liquid in flat gaps of satellite motors working mechanism. *Polish Maritime Research*, No 2/2014. DOI: 10.2478/pomr-2014-0019
24. Stosiak M.: The impact of hydraulic systems on the human being and the environment. *Journal of Theoretical and Applied Mechanics*, Vol. 53 No 2/2015. DOI: 10.15632/jtam-pl.53.2.409
25. Stosiak M.: The modeling of hydraulic distributor slide-sleeve interaction. *Archives of Civil and Mechanical Engineering*, No 2/2012. DOI: 10.1016/j.acme.2012.04.002
26. Stosiak M., Kollek W., Osiński P., Cichon P., Wilczynski A.: Problems relating to high-pressure gear micro-pumps. *Archives of Civil and Mechanical Engineering*, No 1/2014. DOI: 10.1016/j.acme.2013.03.005
27. Walczak P., Sobczyk A.: Simulation of water hydraulic control system of Francis turbine. *American Society of Mechanical Engineers*, 2014. DOI: dx.doi.org/10.1115/FPNI2014-7814
28. Zloto T., Nagorka A.: An efficient FEM for pressure analysis of oil film in a piston pump. *Applied Mathematics and Mechanics*, vol.30, No 1/2009. DOI: 10.1007/s10483-009-0106-z.

CONTACT WITH THE AUTHORS

Paweł Śliwiński
e-mail:pawel.sliwinski@pg.edu.pl

Gdańsk University of Technology
 Faculty of Mechanical Engineering
 11/12 Narutowicza St.
 80 - 233 Gdańsk
POLAND