

Influence of hydraulic oil viscosity on the volumetric losses in a variable capacity piston pump

Jan Koralewski, M. Sc.
Gdańsk University of Technology

ABSTRACT



The variable capacity piston pumps are elements of the great power and highest energy efficiency hydrostatic drives. They are used in the drive systems of ship equipment such as deck cranes, steering gears, main propulsion of smaller vessels. The laboratory and simulation investigations of the influence of liquid viscosity on the variable capacity displacement pump energy losses have not been so far performed.

The paper presents results of the investigations of impact the hydraulic oil viscosity has on the volumetric losses in a piston pump operating in the full range of its capacity and oil pressure.

Key words: hydrostatic drive; displacement pumps; estimation of energy losses; impact of the oil viscosity on losses

INTRODUCTION

A hydraulic system with variable capacity pump, as a structure allowing to change the motor speed, is a hydrostatic drive solution with the highest energy efficiency. It is used in the great power systems, in the situations of prolonged system operation, wherever the energy saving is preferred even with more expensive investment and greater operation requirements. Examples of the ship applications are the drive and control solutions of a deck crane, steering gear and main propulsion of smaller vessels.

It is important to know the transmission energy efficiency in the nominal conditions but also in the whole range of the operating conditions (hydraulic motor load and speed, hydraulic oil viscosity), particularly in the most often occurring or most prolonged operating conditions.

A hydraulic drive system designer or user has at his disposal, provided only by some manufacturers, results of the energy efficiency tests of machines in the systems, tests performed with a selected oil viscosity. The efficiency of a hydraulic motor and its driving pump as elements of a hydrostatic transmission system should be determined as a function of the motor shaft speed and torque.

There is no tool allowing to perform full energy analysis of the hydrostatic transmission as a whole composed of any different set of machines. The transmission system efficiency should be presented as dependent on the hydraulic motor speed and load, with a possibility of evaluating the impact of volumetric, pressure and mechanical losses, different in various types and sizes of the machines used an also evaluation of the impact of pressure losses in the system conduits.

All those losses are also a function of current motor operating parameters and of the oil viscosity changing during the system operation.

So widely understood simulation investigations require a suitable model of the variable capacity pump losses and energy efficiency, and also a model of the system efficiency with such pump. In order to verify the models, it is necessary to carry out carefully prepared laboratory investigations of the pump, hydraulic motor and the whole system. Such investigations, with the constant recommended oil viscosity $\nu_n = 35\text{mm}^2\text{s}^{-1}$ were performed by M. Czyński [1].

The laboratory and simulation investigations of the impact of liquid viscosity on the variable capacity displacement pump energy losses have not been performed yet.

MATHEMATICAL MODELS OF THE DISPLACEMENT MACHINES LOSSES AND ENERGY EFFICIENCY

Assessment of the capability of energy savings in the hydrostatic drive system operation requires the system losses to be defined.

The simulation determination of the system energy efficiency may be used for the purpose in the system design and operation process [2]. The following factors in the simulation model should be taken into account:

- the hydraulic motor speed control system structure,
- energy losses in the system elements,
- the pump driving motor speed decrease,
- the system control element characteristics,

- load and speed of the controlled hydraulic motor,
- hydraulic oil viscosity, changing in the system operation process due to change of the oil temperature.

In order to make the transmission system efficiency determination method easily applicable, it is necessary to:

- 1) use the computer programs for the mathematical models, allowing to analyse the hydraulic system efficiency as a function of the decisive parameters (hydraulic motor speed coefficient $\bar{\omega}_M$ and load coefficient \bar{M}_M , ratio v/v_n of the hydraulic oil viscosity v to the reference viscosity v_n),
- 2) determine the values of energy loss coefficients for the pump, rotational hydraulic motor or hydraulic cylinder. Those coefficients should be clearly defined and precisely determined for a given displacement machine.

The mathematical model of the displacement machine losses allowing to fulfil the conditions given in points 1 and 2 above should take into account:

- a) the form and simplicity of the description, deciding of the possible use of that description in the system efficiency model, with maintaining the system efficiency precise assessment,
- b) description of the displacement machines volumetric losses, allowing to evaluate the impact of hydraulic oil kinematic viscosity changing with oil temperature,
- c) separate treatment of the mechanical and pressure losses in the machine. These losses increase the required torque on the machine (pump) shaft but the losses are of different character and depend on the same parameter (viscosity coefficient v/v_n) but in a different way.

It is necessary to perform the laboratory and simulation investigations in the displacement machine real operating conditions. The investigations should allow to verify the proposed models of:

- machine volumetric losses,
- machine pressure losses,
- machine mechanical losses,

in the full range of working pressure up to nominal pressure p_n , in the wide range of pump capacity up to theoretical capacity Q_{Pt} and in wide range of the hydraulic oil kinematic viscosity v , and also to determine the k_i coefficients of specific losses.

MODEL OF THE DISPLACEMENT PUMP VOLUMETRIC LOSSES

Volumetric losses require an increase of the pump geometrical capacity, are connected first of all with the working liquid leaks through slots between displacement elements and the working chamber walls, distributor (if it exists) elements and are also effect of the liquid compressibility, change of the pump working volume and change of the slot height due to changes of pressure and temperature.

The model of volumetric losses presented by Z. Paszota in [2, 3, 4] meets the requirements given in chapter 2. The author assumes the conditions and simplifications of the impact of certain factors on those losses and that impact is reflected in a coefficient and in power exponents describing the dependence of losses on Δp_{pi} and v .

The theoretical pump working volume q_{Pt} (theoretical capacity q_{Pt} for one pump shaft revolution) – the geometrical difference between the maximum and minimum volume of working chambers – is a characteristic value of a pump. It is determined at the pressure value $p_{pi} = 0$ in the pump working chambers during their filling and at the increase $\Delta p_{pi} = 0$ of the indicated pressure in the chambers.

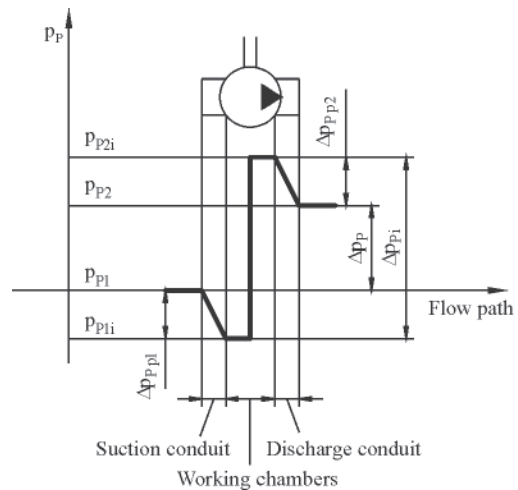

Fig. 1. Approximate changes of the working fluid pressure along the flow in the pump

Under the pressure and temperature, the geometric working volume q_{Pg} of the pump changes slightly compared with q_{Pt} . It is assumed (in order to simplify the description of volumetric loss intensity Q_{Pv} in the pump) that the theoretical pump working volume q_{Pt} is constant and equal to the geometrical working volume q_{Pg} determined at the working liquid temperature corresponding to the recommended kinematic viscosity $v_n = 35 \text{ mm}^2\text{s}^{-1}$:

$$q_{Pt} = q_{Pg} \begin{cases} p_{pi}=0 \\ \Delta p_{pi}=0 \\ v_n \end{cases} \quad (1)$$

and the change of geometric working volume q_{Pg} during the system operation will be taken into account in the values of loss coefficients in the pump.

The theoretical capacity Q_{Pt} of a constant capacity pump is given by the formula:

$$Q_{Pt} = q_{Pt} n_{p0} \quad (2)$$

where:

n_{p0} – the rotational shaft speed of an unloaded pump ($\Delta p_{pi} = 0$).

The intensity Q_{Pv} of the pump volumetric losses is described by a simulation model:

$$Q_{Pv} = k_{Pv35} \frac{q_{Pt}}{\rho_n v_n} \Delta p_{pi} \left(\frac{v}{v_n} \right)^{-0.8} \quad (3)$$

where:

k_{Pv35} – dimensionless constant of volumetric losses in the pump, determined experimentally at the reference viscosity $v_n = 35 \text{ mm}^2\text{s}^{-1}$,

q_{Pt} – theoretical working volume of a constant capacity pump,

ρ_n – reference mass density of the working medium (hydraulic oil) determined at the temperature corresponding to the kinematic viscosity v_n and pressure $p = 0$ (atmospheric pressure),

Δp_{pi} – indicated pressure increase in the pump working chambers,

v – kinematic viscosity of the working medium (hydraulic oil) used for calculation of the volumetric losses Q_{Pv} and determined at the pump inlet,

v_n – reference kinematic viscosity of the working medium (hydraulic oil) $v_n = 35 \text{ mm}^2\text{s}^{-1}$, determined at the pressure $p = 0$ (atmospheric pressure),

$(v/v_n)^{-0.8}$ – approximate description of the impact of liquid viscosity v on the volumetric losses in a displacement rotational machine.

The value -0.8 of the exponent takes into account first of all two types of volumetric losses in the pump – dominating leaks of the laminar flow, proportional to $(v/v_n)^{-1}$ and leaks of the not fully developed turbulent flow, proportional to $(v/v_n)^{-0.14}$. Therefore, the -0.8 exponent may be replaced by a different value in a more precise description of the intensity Q_{pv} of volumetric losses in specific pump.

The value of that exponent must be determined experimentally for each type of a displacement pump.

The pump capacity Q_p is described by the expression:

$$Q_p = q_{Pt} n_p - k_{pv35} \frac{q_{Pt}}{\rho_n v_n} \Delta p_{Pi} \left(\frac{v}{v_n} \right)^{-0.8} \quad (4)$$

where: the speed n_p lower or equal to n_{p0} , depends on the characteristic of the pump driving motor (n_p decreases when the torque M_p required by the pump increases).

Coefficient k_1 of the volumetric losses Q_{pv} , determined during one shaft revolution of a constant or variable capacity pump, at the pressure increase Δp_{Pi} equal to the hydraulic system nominal pressure $\Delta p_{Pi} = p_n$ and at the viscosity v_n , the losses related to the pump theoretical working volume q_{Pt} , is described by the formula:

$$k_1 = \frac{Q_{pv} \left| \frac{q_{Pt}}{\Delta p_{Pi} = p_n} \frac{1}{v_n} \right.}{n_p \left| \frac{q_{Pt}}{\Delta p_{Pi} = p_n} \frac{1}{v_n} \right.} \quad (5)$$

The relation between coefficient k_1 and the constant value k_{pv35} of the volumetric losses in the pump is the following:

$$k_1 = k_{pv35} \frac{p_n}{\rho_n v_n n_p \left| \frac{q_{Pt}}{\Delta p_{Pi} = p_n} \frac{1}{v_n} \right.} \quad (6)$$

The relation between coefficient $k_{1|v}$ calculated at the oil viscosity v changing during the drive system operation and coefficient k_1 is the following:

$$k_{1|v} = k_1 \left(\frac{v}{v_n} \right)^{-0.8} \quad (7)$$

It results from the presence of two types of volumetric losses in the pump: dominating leaks of the laminar flow and leaks of not fully developed turbulent flow.

Using the volumetric loss coefficient k_1 , the following formula for the intensity Q_{pv} of volumetric losses is obtained:

$$Q_{pv} = k_1 q_{Pt} n_p \left| \frac{q_{Pt}}{\Delta p_{Pi} = p_n} \left(\frac{\Delta p_{Pi}}{p_n} \right)^1 \left(\frac{v}{v_n} \right)^{-0.8} \right. \quad (8)$$

and the pump capacity Q_p formula:

$$Q_p = q_{Pt} n_p - k_1 q_{Pt} n_p \left| \frac{q_{Pt}}{\Delta p_{Pi} = p_n} \left(\frac{\Delta p_{Pi}}{p_n} \right)^1 \left(\frac{v}{v_n} \right)^{-0.8} \right. \quad (9)$$

The use of coefficient k_1 of volumetric losses for description of the relation of Q_{pv} intensity to the indicated increase Δp_{Pi}

of pressure in the pump working chambers allows to describe that relation by an exponential function with the exponent not necessarily equal to 1. The use of k_{pv35} constant to the description of Q_{pv} required an assumed proportionality of Q_{pv} to Δp_{Pi} .

The expressions describing the variable capacity pump capacity takes the form:

$$Q_p = b_p q_{Pt} n_p - k_{pv35} \frac{q_{Pt}}{\rho_n v_n} \Delta p_{Pi} \left(\frac{v}{v_n} \right)^{-0.8} \quad (10)$$

or:

$$Q_p = b_p q_{Pt} n_p - k_1 q_{Pt} n_p \left| \frac{q_{Pt}}{\Delta p_{Pi} = p_n} \left(\frac{\Delta p_{Pi}}{p_n} \right)^1 \left(\frac{v}{v_n} \right)^{-0.8} \right. \quad (11)$$

The expressions (10, 11) assume, that change of the pump capacity setting b_p (change of the pump capacity) does not influence the intensity of pump volumetric losses Q_{pv} .

In the expressions (9, 11) the value 1 of exponent describing the impact of the $\Delta p_{Pi}/p_n$ ratio and also the value -0.8 of exponent describing the impact of the v/v_n ratio on the intensity Q_{pv} of pump volumetric losses should take into account all the factors influencing the volumetric losses (character of the flow in slots, change of the slots cross-section with pressure and temperature, liquid compressibility, change of the liquid viscosity in slots etc.).

The value 1 of exponent describing the impact of the $\Delta p_{Pi}/p_n$ ratio and also the value -0.8 of exponent describing the impact of the v/v_n ratio on the intensity Q_{pv} of pump volumetric losses must be verified experimentally for each pump type.

RESULTS OF THE LABORATORY INVESTIGATIONS

Laboratory investigations of an axial piston variable displacement pump of bent axis design (BOSCH REXROTH A7V58RD type) were carried out on a test stand in the Chair of Hydraulics and Pneumatics of the Gdańsk University of Technology Mechanical Engineering Faculty.

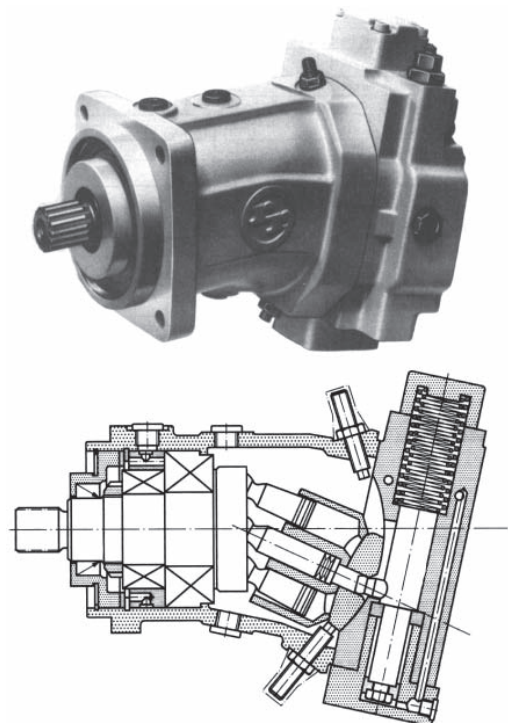

Fig. 2. Axial piston variable displacement pump of bent axis design (BOSCH REXROTH A7V58RD type)

The investigations were performed with:

- 8 temperatures of hydraulic oil (oil kinematic viscosity ν):
 $\nu = 20^\circ\text{C}$ ($\nu = 120.40 \text{ mm}^2\text{s}^{-1}$), $\nu = 24^\circ\text{C}$ ($\nu = 91.16 \text{ mm}^2\text{s}^{-1}$),
 $\nu = 30^\circ\text{C}$ ($\nu = 65.37 \text{ mm}^2\text{s}^{-1}$), $\nu = 36^\circ\text{C}$ ($\nu = 47.05 \text{ mm}^2\text{s}^{-1}$),
 $\nu = 43^\circ\text{C}$ ($\nu = 34.68 \text{ mm}^2\text{s}^{-1}$), $\nu = 50^\circ\text{C}$ ($\nu = 26.41 \text{ mm}^2\text{s}^{-1}$),
 $\nu = 60^\circ\text{C}$ ($\nu = 18.77 \text{ mm}^2\text{s}^{-1}$), $\nu = 68^\circ\text{C}$ ($\nu = 14.53 \text{ mm}^2\text{s}^{-1}$),
- 8 values of the increase Δp_p of pump pressure:
 $\Delta p_p = 1.6 \text{ MPa}$, $\Delta p_p = 3.2 \text{ MPa}$, $\Delta p_p = 6.3 \text{ MPa}$,
 $\Delta p_p = 10 \text{ MPa}$, $\Delta p_p = 16 \text{ MPa}$, $\Delta p_p = 20 \text{ MPa}$,
 $\Delta p_p = 25 \text{ MPa}$, $\Delta p_p = 32 \text{ MPa}$

- 7 values of pump capacity coefficient:
 $b_p = 0.227$; $b_p = 0.361$; $b_p = 0.493$;
 $b_p = 0.623$; $b_p = 0.752$; $b_p = 0.880$; $b_p = 1$.

The selected method of determination of the geometrical (variable) capacity $q_{p_{gv}}$ per one pump shaft revolution and theoretical capacity q_{p_t} per one shaft revolution was based on the extrapolation of linear functions $q_p = f(\Delta p_{p_i})$, in the range of small increases Δp_{p_i} of pressure in the pump working chambers (Fig. 3).

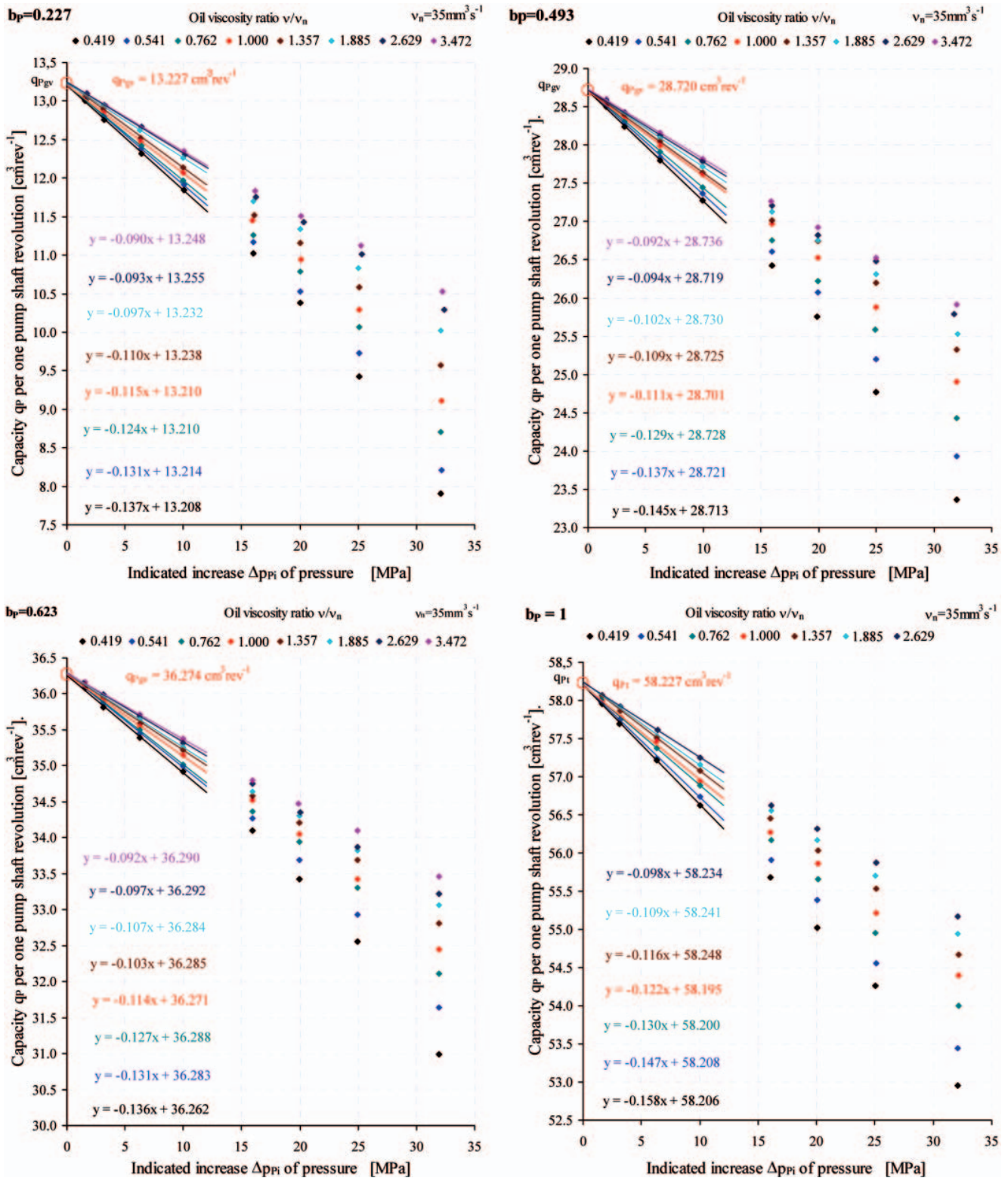

Fig. 3. Determination of the geometrical (variable) capacity $q_{p_{gv}}$ ($q_{p_{gv}} = b_p \cdot q_{p_t}$) per one shaft revolution and of the value of the pump capacity coefficient b_p from the relation of the pump capacity q_p per one shaft revolution to the indicated increase Δp_{p_i} of pressure in the pump working chambers at different values of the oil viscosity ratio v/v_n ; examples for four choices of different pump capacity settings $b_p = 0.227 \div 1$

Description of $q_p = f(\Delta p_{pi})$, with those linear functions in the range of small pressure increases Δp_{pi} , allowed to determine $q_{p_{gv}}$ (q_{pt}) with the accuracy of an order of 1 per mille (0.001). Approximation, instead with a linear function in the whole

range of the increase Δp_{pi} of pressure (up to 32 MPa) or a second degree polynomial or an exponential function in the whole or a small range of Δp_{pi} allowed to determine $q_{p_{gv}}$ (q_{pt}) with much less accuracy.

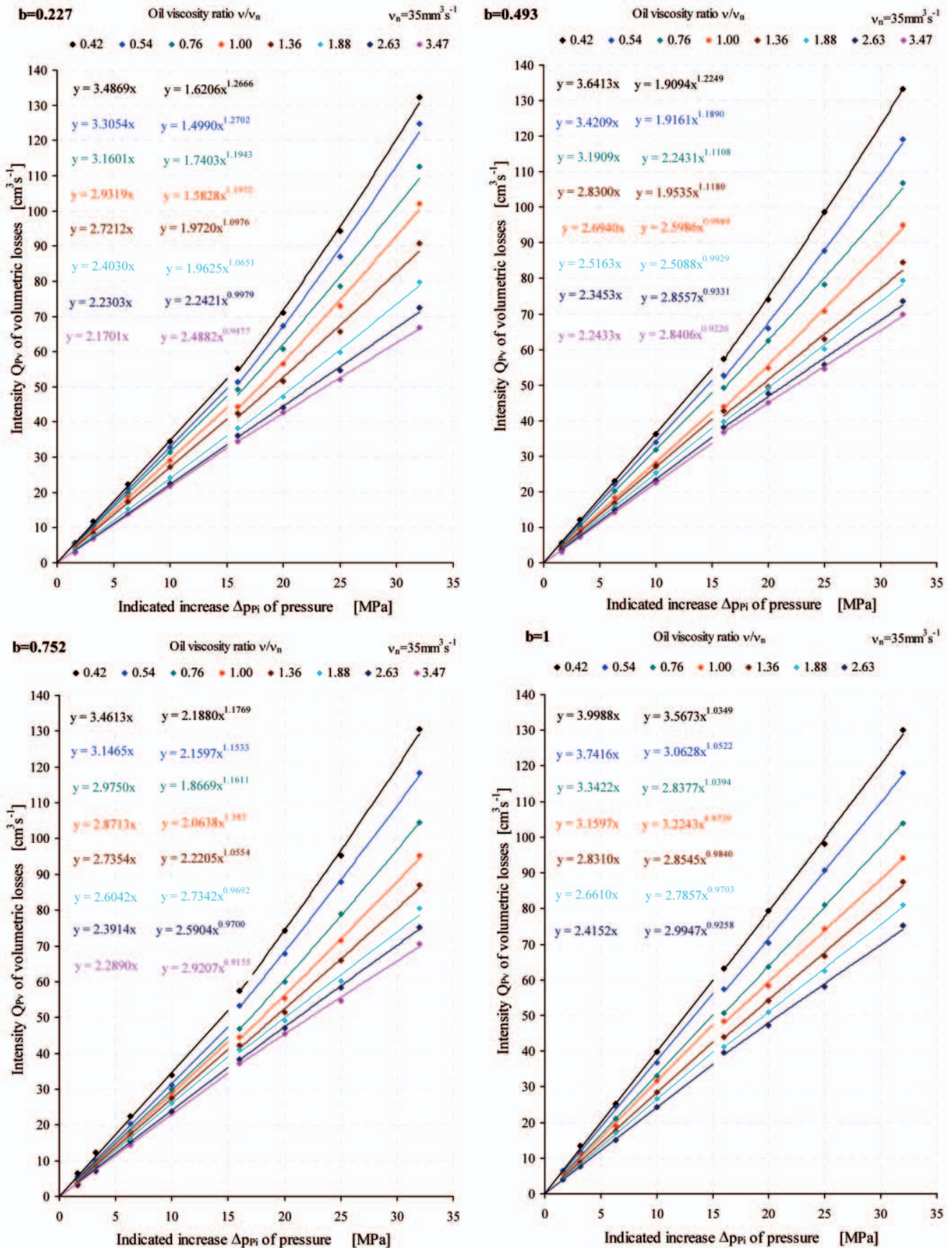

Fig. 4. Relation of the intensity Q_{pv} of volumetric losses to the indicated increase Δp_{pi} of pressure in the pump with different values of the oil viscosity ratio v/v_n ; examples for four chosen values of the pump capacity coefficient $b_p = 0.227 \div 1$. In the range up to $\Delta p_{pi} = 16$ MPa, the Q_{pv} intensity is most precisely described by the linear functions, in the $\Delta p_{pi} = 16 \div 32$ MPa range, the Q_{pv} intensity is described by exponential functions

The figure 4 demonstrates a complex impact on Q_{pv} of the flow character in the slots and of the changes of slot cross-section and the hydraulic oil viscosity under the influence of pressure and temperature.

Choice of the functions (Fig. 5) assumes the best conformity with the measurement results at $\Delta p_{pi} = p_n$. A consequence of the choice of such functions is worse conformity with the measurement results at lower Δp_{pi} values.

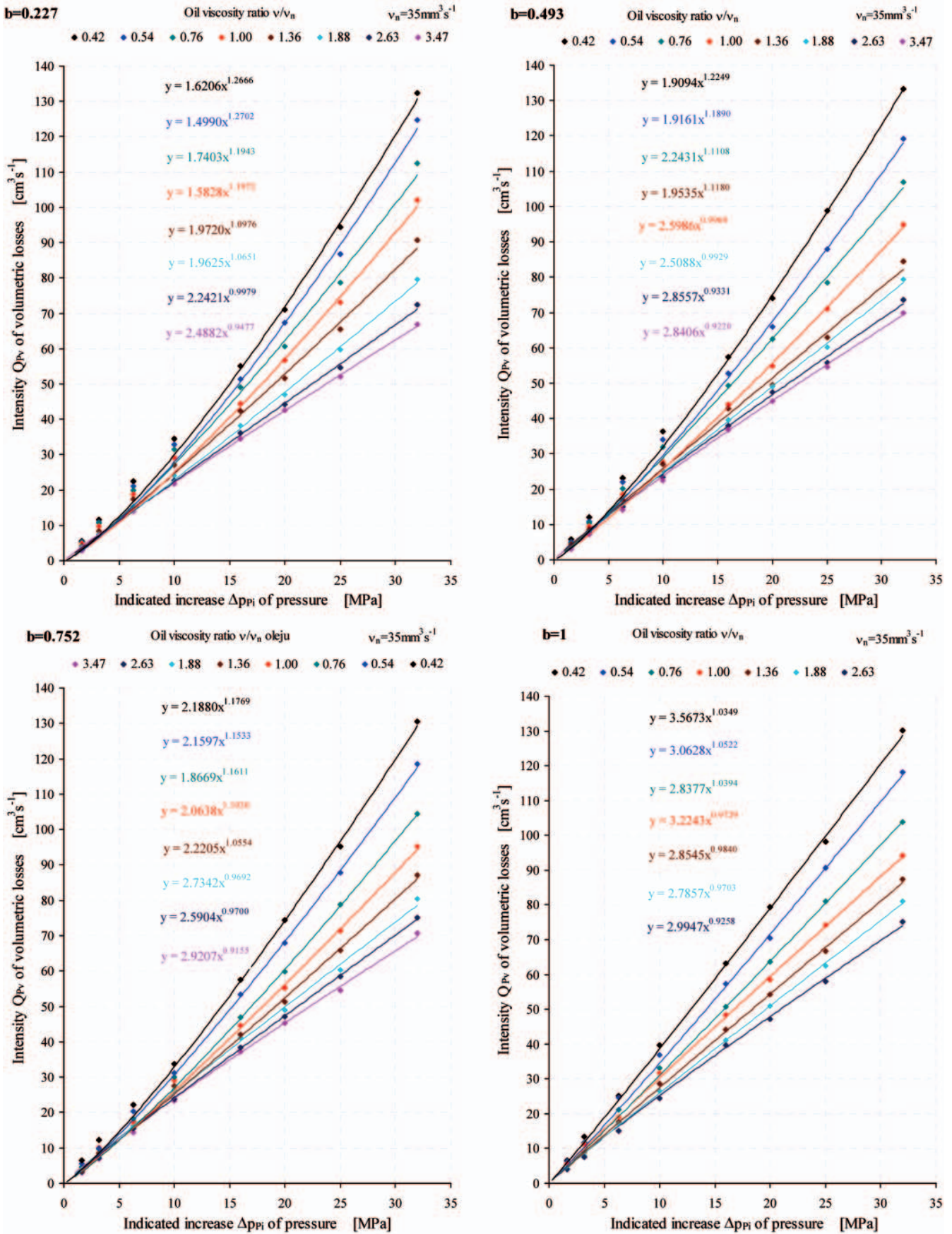

Fig. 5. Relation of the intensity Q_{pv} of volumetric losses to the indicated increase Δp_{pi} of pressure in the pump, described by exponential functions in the whole range of pressure; examples for four chosen pump capacity coefficients $b_p = 0.227 \div 1$

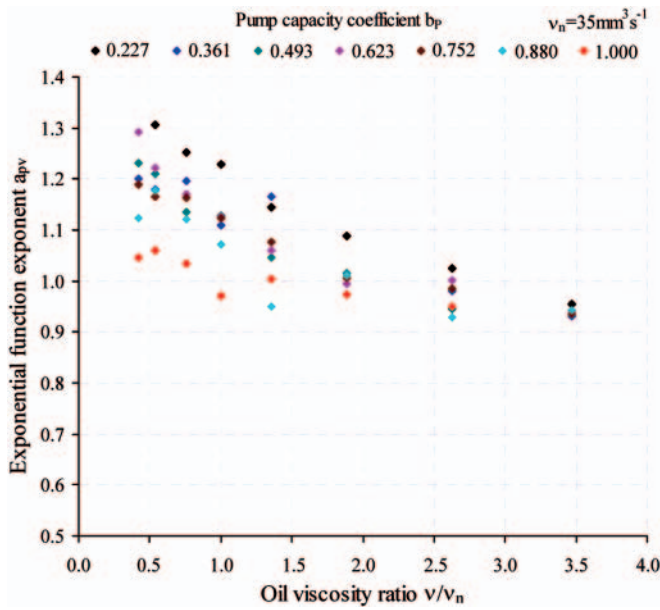

Fig. 6. Value of the a_{pv} exponent (in the exponential function describing the relation of the intensity Q_{pv} of volumetric losses to the indicated increase Δp_{pi} of pressure in the pump) at changing pump capacity coefficient b_p for different oil viscosity ratios v/v_n

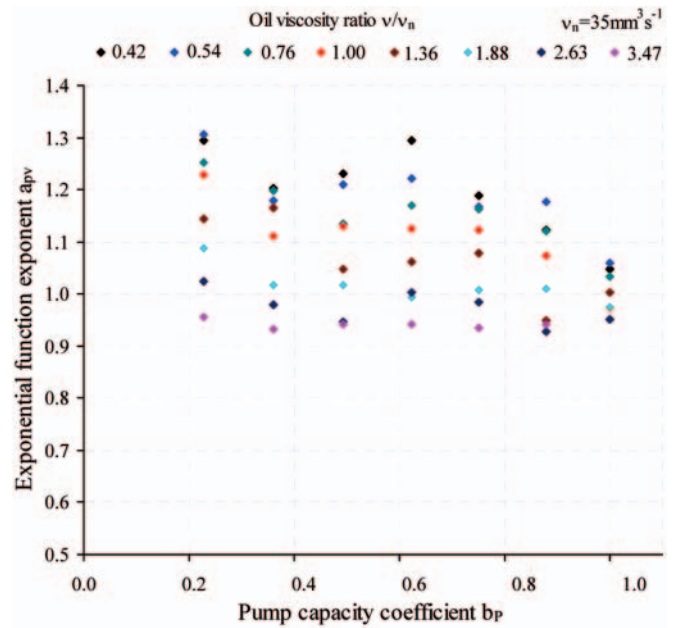

Fig. 7. Value of the a_{pv} exponent (in the exponential function describing the relation of the intensity Q_{pv} of volumetric losses to the indicated increase Δp_{pi} of pressure in the pump) at changing oil viscosity ratio v/v_n for different pump capacity coefficients b_p

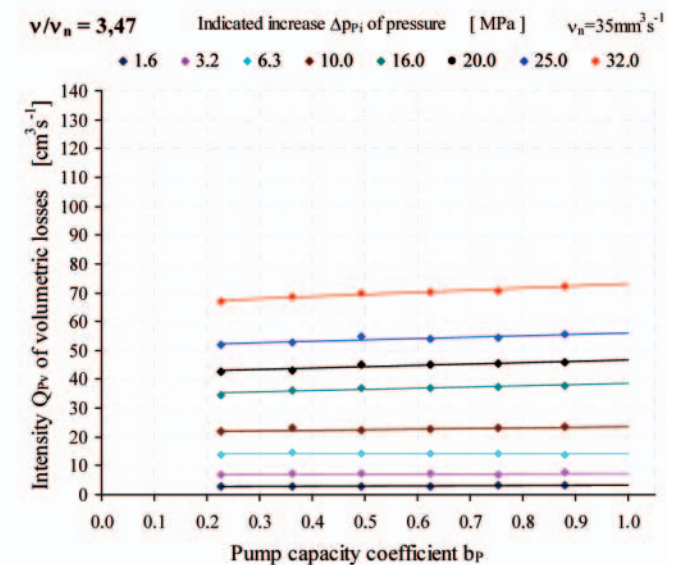
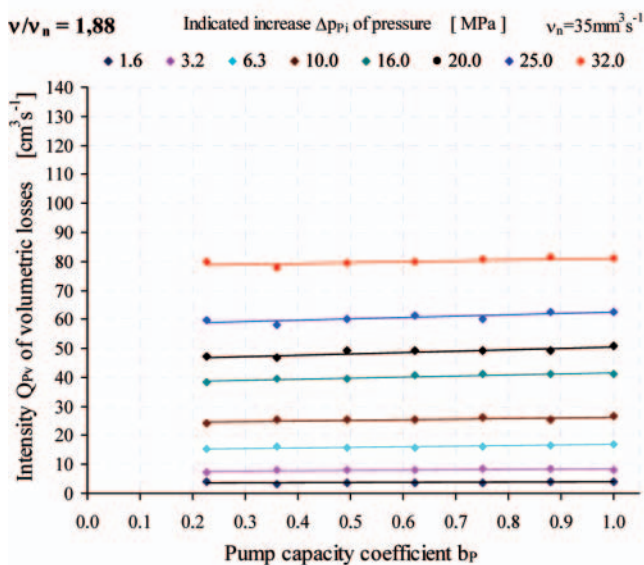
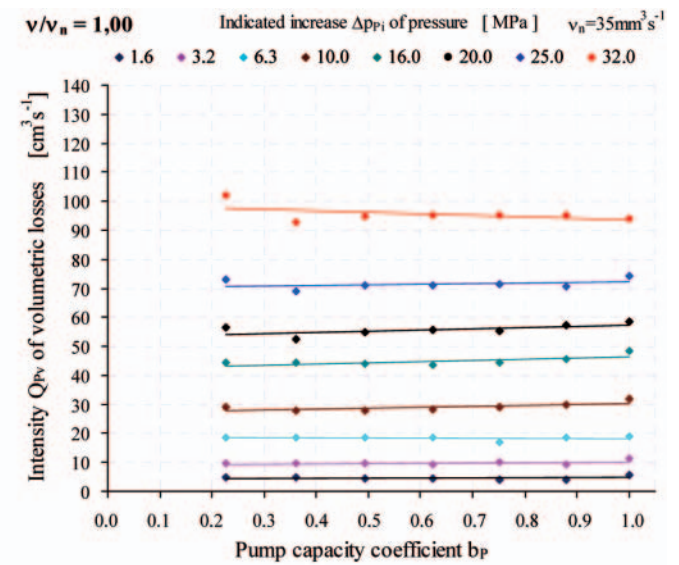
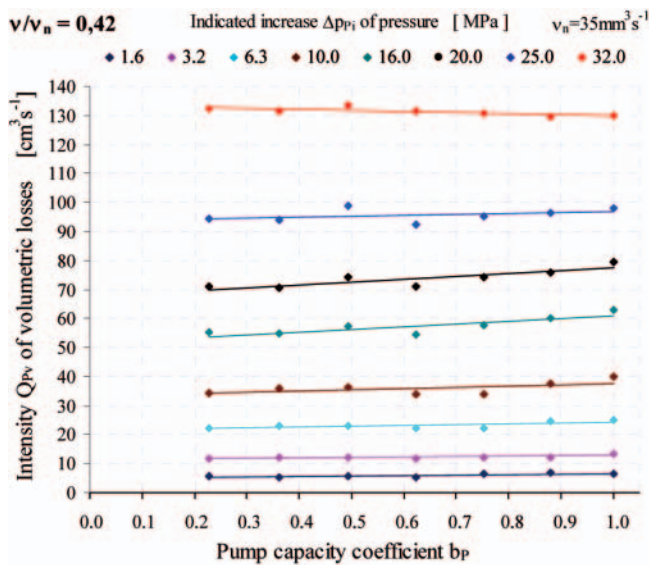

Fig. 8. Relation of the intensity Q_{pv} of volumetric losses to the pump capacity coefficient b_p at different values of indicated increase Δp_{pi} of pressure in the pump working chambers and at different $v/v_n = 0.42 \div 3.47$ ratios of oil viscosity

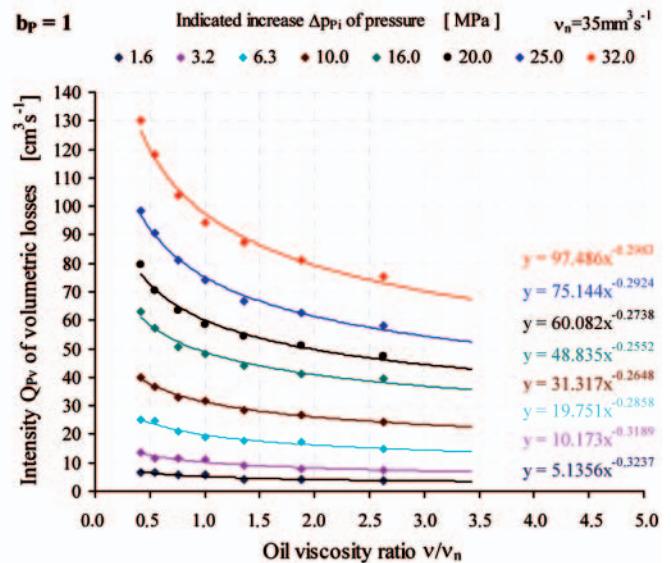
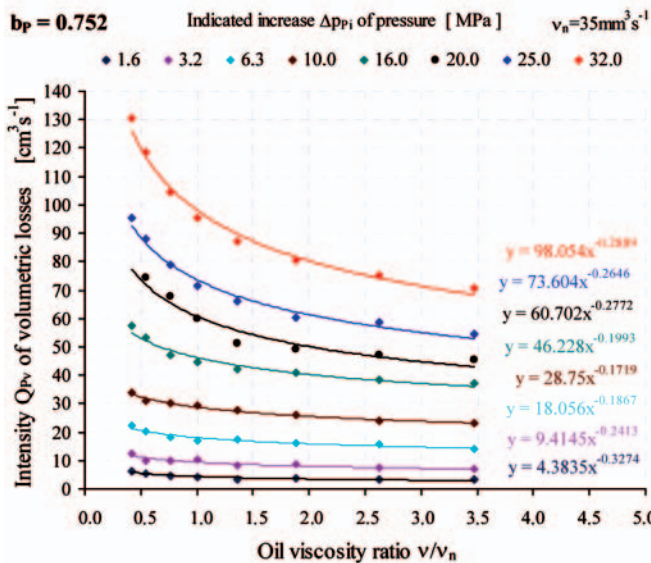
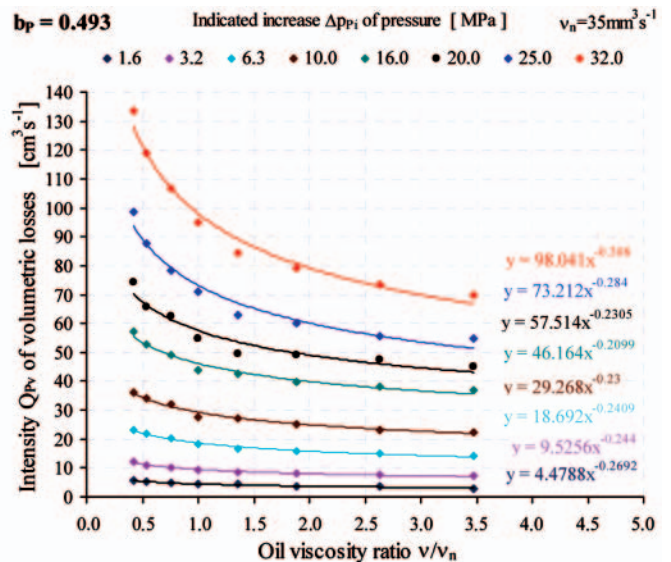
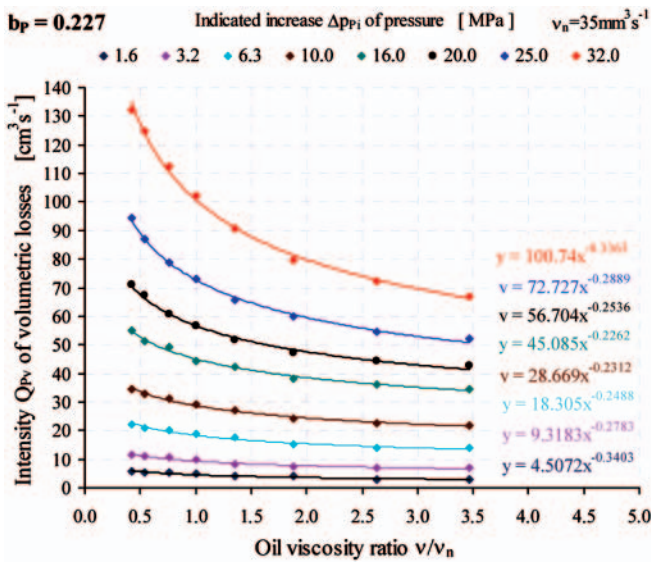

Fig. 9. Relation of the intensity Q_{pv} of volumetric losses to the oil viscosity ratio v/v_n at different values of indicated increase Δp_{pi} of pressure in the pump working chambers and at different values of the pump capacity coefficient $b_p = 0.227 \div 1$

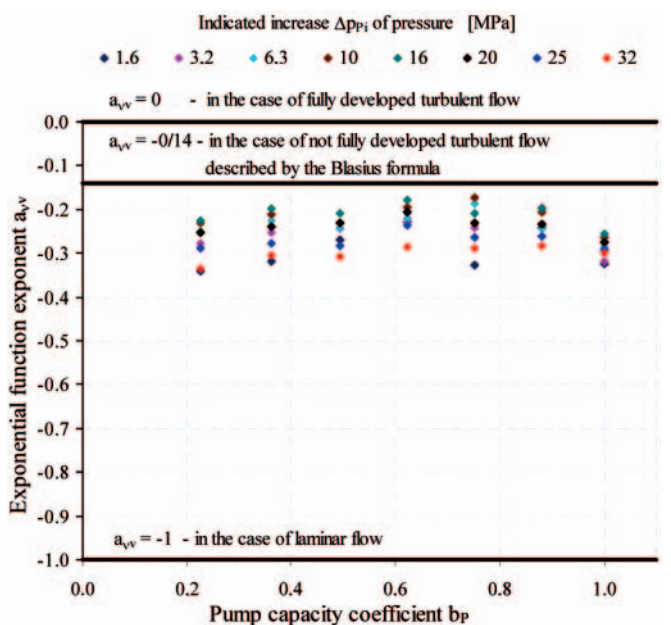
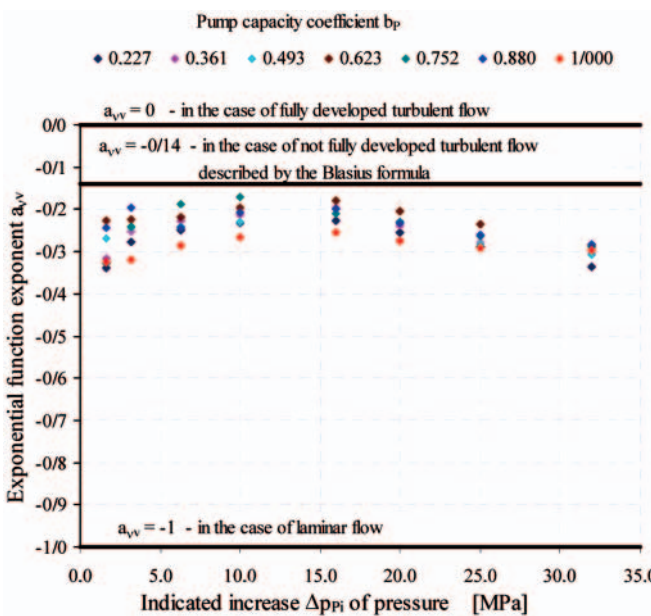

Fig. 10. Value of the a_{vv} exponent (in the exponential function describing the relation of the intensity Q_{pv} of volumetric losses to the oil viscosity ratio v/v_n) at changing indicated increase Δp_{pi} of pressure in the pump for different values of the pump capacity coefficient b_p

Fig. 11. Value of the a_{vv} exponent (in the exponential function describing the relation of the intensity Q_{pv} of volumetric losses to the oil viscosity ratio v/v_n) at changing pump capacity coefficient b_p and for different values of the indicated increase Δp_{pi} of pressure in the pump

Values of the a_{pv} exponent, in the exponential function describing the relation of the intensity Q_{pv} of volumetric losses to the indicated increase Δp_{pi} of pressure in the pump, presented in figures 6 and 7, are within the $0.91 < a_{pv} < 1.31$ range. This range is limited to $0.91 < a_{pv} < 0.96$ at the oil viscosity ratio $v/v_n = 3.47$.

The exponent values $a_{pv} < 1$ obtained at the highest oil viscosity allow to conclude that in the whole range of viscosity v the flow in slots is of a not fully developed turbulent character (with increasing turbulence at decreasing viscosity). Increase of the a_{pv} exponent above 1 at decreasing viscosity v indicates an impact of the slot increase upon the intensity Q_{pv} of volumetric losses as an effect of temperature increase.

The pump capacity coefficient b_p has practically no impact on the intensity Q_{pv} of volumetric losses in the pump working chambers (Fig. 8).

Values of the a_{vv} exponent in the exponential function describing the relation of the intensity Q_{pv} of volumetric losses to the oil viscosity ratio v/v_n , presented in figures 9, 10 and 11, in the $a_{vv} = -0.20 \div -0.35$ range indicate the domination of not fully developed turbulent flow over laminar flow in the pump slots.

VERIFICATION OF THE MATHEMATICAL MODEL OF PUMP VOLUMETRIC LOSSES

In order to verify the mathematical model described by formula (8), it was replaced by a mathematical expression taking into account the relations, obtained during the investigations, of the intensity Q_{pv} of pump volumetric losses to the indicated

increase Δp_{pi} of pressure in the pump working chambers (to the $\Delta p_{pi}/p_n$ ratio) and also to the oil viscosity ratio v/v_n :

$$Q_{pv} = k_1 q_{pt} n_p \left| \frac{q_{pt}}{\Delta p_{pi} = p_n} \frac{v_n}{p_n} \right| \left(\frac{\Delta p_{pi}}{p_n} \right)^{a_{pv}} \left(\frac{v}{v_n} \right)^{a_{vv}} \quad (12)$$

Assumed was (Fig. 12) the value of exponent $a_{pv} = 0.97$ in the formula (12) determined with the pump capacity coefficient $b_p = 1$, the oil viscosity ratio $v/v_n = 1$ and the coefficient of volumetric losses $k_1 = 0.065$ calculated from formula (5).

Assumed was (Fig. 13) the value of exponent $a_{vv} = -0.30$ in the formula (12) determined with the pump capacity coefficient $b_p = 1$, $\Delta p_{pi}/p_n = 1$ ratio and the calculated coefficient of volumetric losses $k_1 = 0.065$.

The obtained values of the coefficient $k_1 = 0.065$ of intensity Q_{pv} of volumetric losses, exponent $a_{pv} = 0.97$ of the relation of intensity Q_{pv} of the volumetric losses to the ratio $\Delta p_{pi}/p_n$ of the pressure increase, exponent $a_{vv} = -0.30$ of the relation of intensity Q_{pv} of the volumetric losses to the v/v_n ratio of oil viscosity, have made it possible to present the mathematical model of the intensity Q_{pv} of pump volumetric losses in the form:

$$Q_{pv} = 0.065 q_{pt} n_p \left| \frac{q_{pt}}{\Delta p_{pi} = p_n} \frac{v_n}{p_n} \right| \left(\frac{\Delta p_{pi}}{p_n} \right)^{0.97} \left(\frac{v}{v_n} \right)^{-0.30} \quad (13)$$

Model (13) describes precisely the intensity Q_{pv} of volumetric losses in the nominal conditions of the pump operation, i.e. at the pump capacity coefficient $b_p = 1$, the pressure increase ratio $\Delta p_{pi}/p_n = 1$ and the oil viscosity ratio

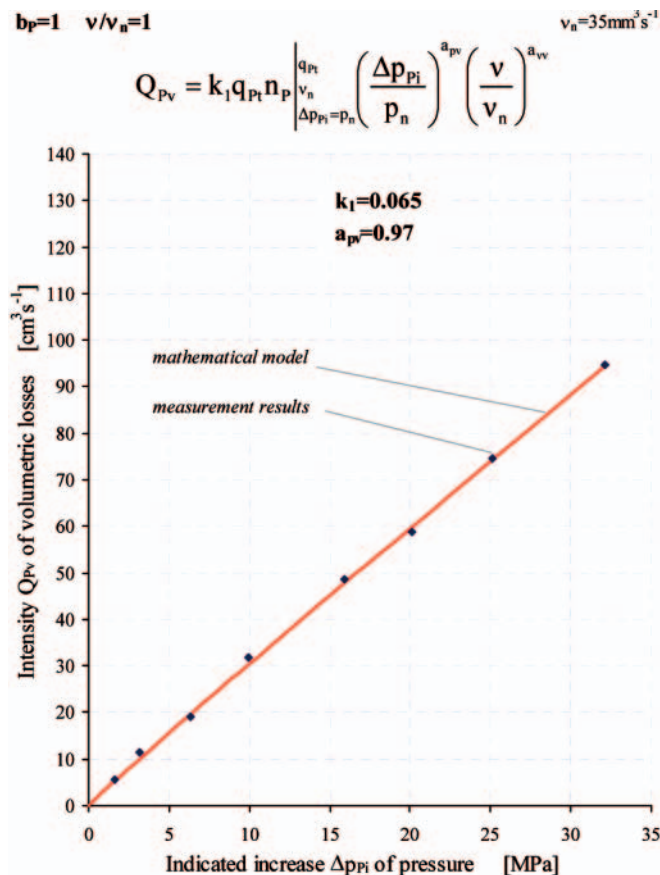

Fig. 12. Determination of the a_{pv} exponent in the mathematical model describing the relation of the intensity Q_{pv} of volumetric losses to the indicated increase Δp_{pi} of pressure in the pump working chambers; pump capacity coefficient $b_p = 1$, the oil viscosity ratio $v/v_n = 1$. From formula (5), the value of coefficient $k_1 = 0.065$ of volumetric losses is determined. The value of $a_{pv} = 0.97$ exponent is obtained

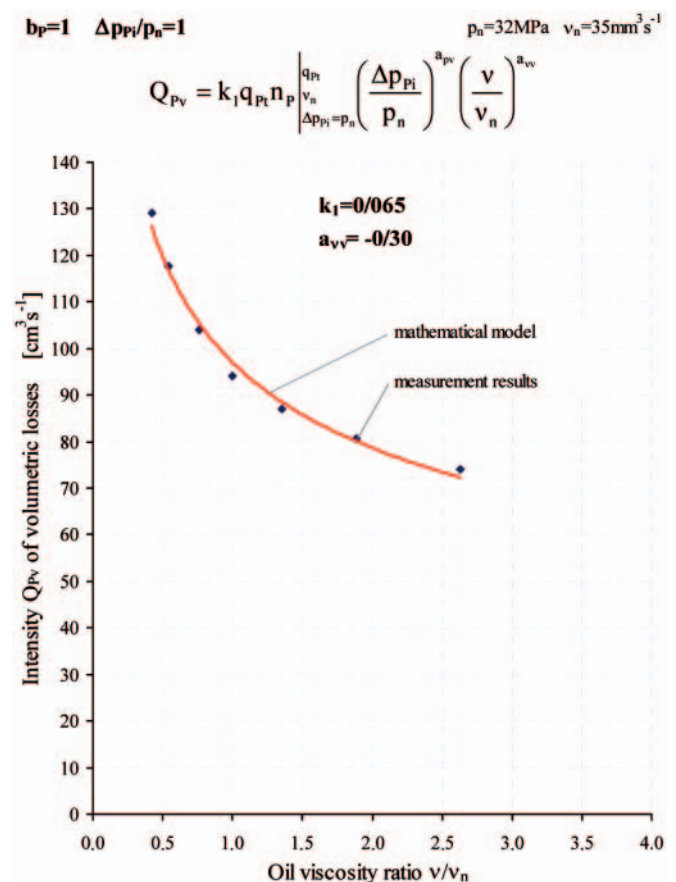

Fig. 13. Determination of the a_{vv} exponent in the mathematical model describing the relation of the intensity Q_{pv} of volumetric losses to the oil viscosity ratio v/v_n ; pump capacity coefficient $b_p = 1$, indicated increase $\Delta p_{pi} = p_n = 32 \text{ MPa}$ of pressure in the pump working chambers, coefficient $k_1 = 0.065$ of volumetric losses. The value $a_{vv} = -0.30$ of the exponent is obtained

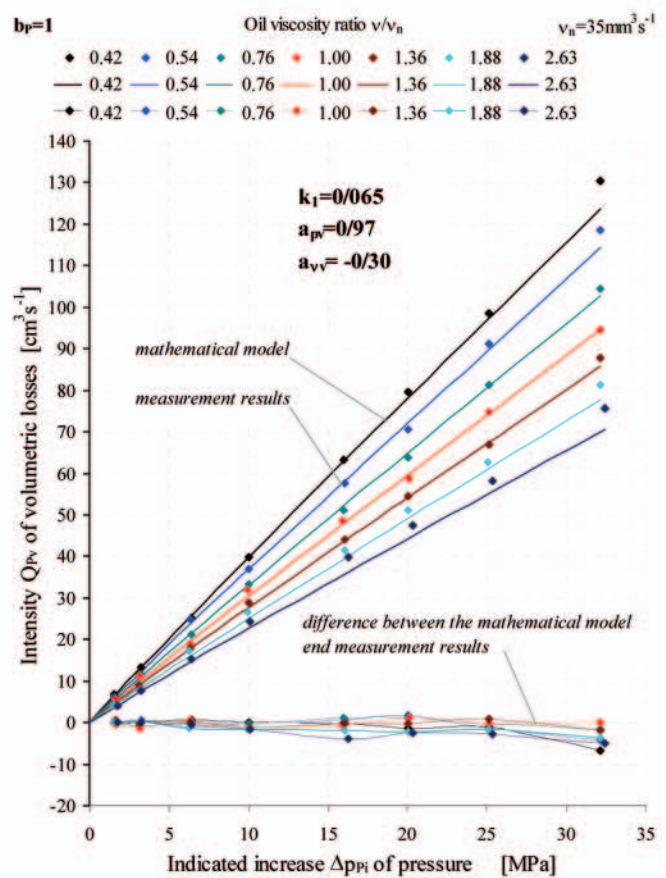
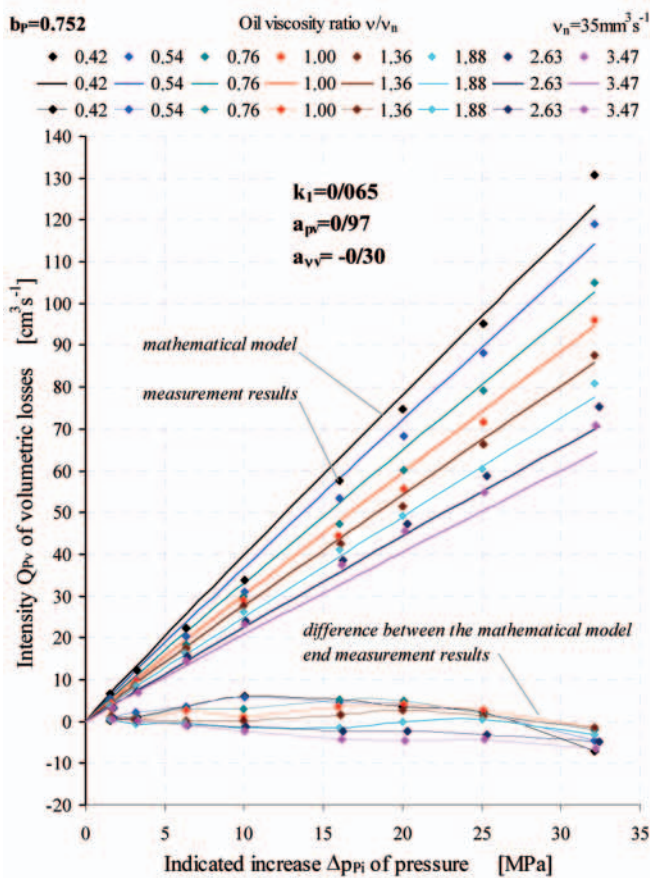
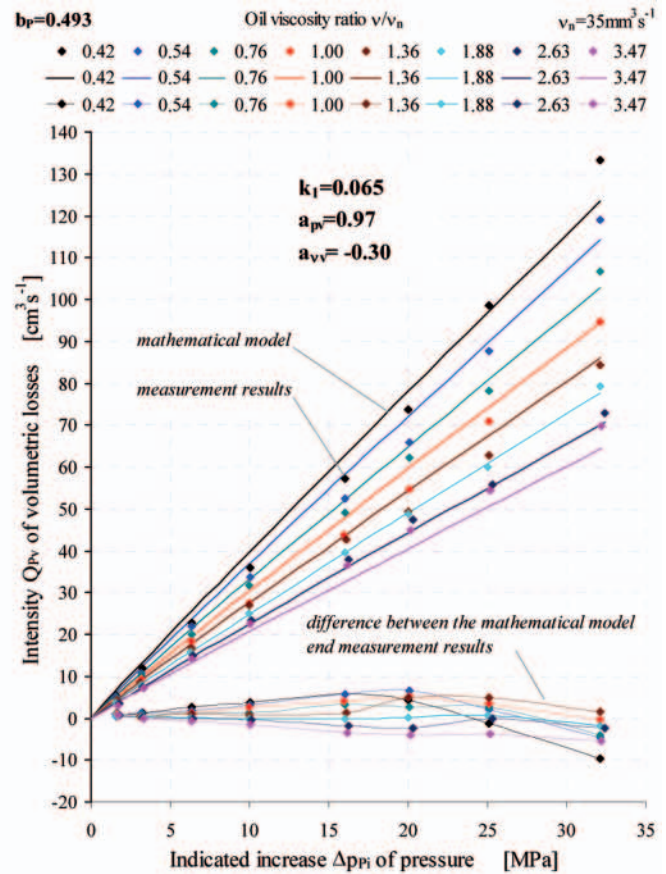
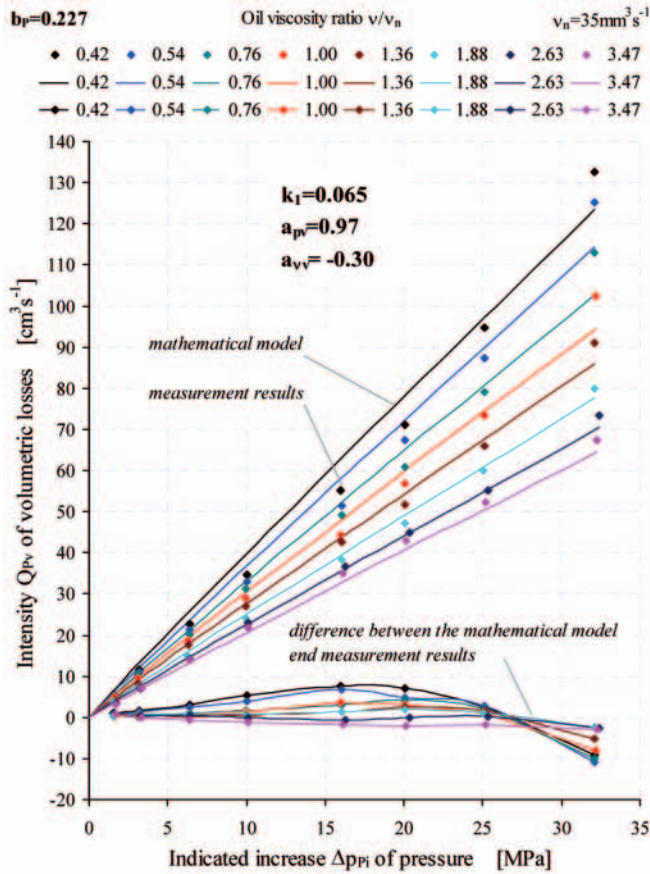

Fig. 14. Comparison of the intensity Q_{pv} of volumetric losses described by the mathematical model (13) with the laboratory investigation results and the absolute difference between the mathematical model values and the laboratory investigation values; assumed were: the coefficient $k_1 = 0.065$ of volumetric losses, exponent $a_{pv} = 0.97$, exponent $a_{vv} = -0.30$; examples for four chosen values of the pump capacity coefficient $b_p = 0.227 \div 1$

$v/v_n = 1$. At the same time this model is a simulation formula describing the change of intensity Q_{pv} of volumetric losses with the change of the pressure increase ratio $\Delta p_{pi}/p_n$ and the oil viscosity ratio v/v_n (the change of pump capacity coefficient b_p has practically no impact on the change of intensity Q_{pv} of volumetric losses).

Figure 14 presents a comparison of the intensity Q_{pv} of volumetric losses described by the mathematical model (13) with the results of laboratory investigations, supplemented by the information about the absolute difference between the values from the mathematical model (13) and results of laboratory investigations. Examples are given for four selected values of the pump capacity coefficient b_p .

Differences between the simulation and experimental values of the intensity Q_{pv} of volumetric losses, determined in the whole range of the pressure increase ratio $\Delta p_{pi}/p_n$, oil viscosity ratio v/v_n and pump capacity coefficient b_p are mainly caused by the change of a_{pv} exponent describing the relation of the intensity Q_{pv} of volumetric losses to the pressure increase ratio $\Delta p_{pi}/p_n$ in the situation of using in the mathematical model the value $a_{pv} = 0.97$ determined at $b_p = 1$ and $v/v_n = 1$.

CONCLUSIONS

1. The purpose of the investigations was experimental verification of the mathematical model (8) [2, 3, 4], describing the volumetric losses in a variable capacity displacement pump used in hydrostatic transmissions. Model (8) allows to describe the losses and the energy efficiency of the pump and hydrostatic drive as a function of the drive speed and load and also the hydraulic oil viscosity.
2. Model (8) allows a simple and precise determination of the pump volumetric losses by determining the coefficient k_1 of volumetric losses (5) in the nominal conditions of pump operation – at $\Delta p_{pi} = p_n$, $b_p = 1$, $v/v_n = 1$.
3. Model (8) allows also to determine the impact of the ratio $\Delta p_{pi}/p_n$ of pressure increase, the hydraulic oil viscosity ratio v/v_n on the intensity Q_{pv} of volumetric losses in the whole range of the pump capacity coefficient b_p .
4. The investigations were carried out with an axial piston variable displacement pump of bent axis design, commonly used in hydrostatic transmissions.
5. In order to verify the mathematical model (8), it was replaced by formula (12) for investigating the exponent a_{pv} in the expression $Q_{pv} \sim (\Delta p_{pi}/p_n)^{a_{pv}}$ and exponent a_{vv} in the expression $Q_{pv} \sim (v/v_n)^{a_{vv}}$.
6. The chosen method of determining the pump geometrical working volume $q_{p_{gv}}$ and theoretical working volume $q_{p_{t}}$ was based on extrapolation of linear functions $q_p = f(\Delta p_{pi})$ within the range of small pressure increases Δp_{pi} in the working chambers. This allows to determine $q_{p_{gv}}$ ($q_{p_{t}}$) with the accuracy of an order of 1 per mille (0.001).
7. A complex impact on the intensity Q_{pv} of volumetric losses was found of the character of flow in slots as well as the impact on Q_{pv} of the change of slot cross-sections and hydraulic oil viscosity v due to the change of pressure and temperature. Up to $\Delta p_{pi} = 16$ MPa, the intensity Q_{pv} was best described with linear functions, in the $\Delta p_{pi} = 16 \div 32$ MPa range the intensity Q_{pv} is described by exponential functions. For description of the Q_{pv} to Δp_{pi} relation in the whole range of the pressure increase, the exponential functions giving the best agreement with the measurement results in the $\Delta p_{pi} = p_n$ area were chosen.
8. The values of exponent a_{pv} in the expression $Q_{pv} \sim (\Delta p_{pi}/p_n)^{a_{pv}}$ are in the $0.91 < a_{pv} < 1.31$ range narrowing to the $0.91 < a_{pv} < 0.96$ range at the oil viscosity ratio $v/v_n = 3.47$.

9. It has been found out that the pump capacity coefficient b_p has practically no impact on the intensity Q_{pv} of pump volumetric losses.
10. The values of exponent a_{vv} in the expression $Q_{pv} \sim (v/v_n)^{a_{vv}}$ are in the $-0.35 < a_{vv} < -0.20$ range and show the domination of not fully developed turbulent flow over the laminar flow in the pump slots in the whole range of investigation parameters.
11. The value $k_1 = 0.065$ of the coefficient of the volumetric losses in the pump working chambers was calculated at the pump capacity coefficient $b_p = 1$, the pressure increase ratio $\Delta p_{pi}/p_n = 1$ and the oil viscosity ratio $v/v_n = 1$. The so determined value of k_1 coefficient allows the quantitative and qualitative evaluation of the pump volumetric losses.
12. The value $a_{pv} = 0.97$ of the exponent in the expression $Q_{pv} \sim (\Delta p_{pi}/p_n)^{a_{pv}}$ was determined at the pump capacity coefficient $b_p = 1$ and the oil viscosity ratio $v/v_n = 1$.
13. The value $a_{vv} = -0.30$ of the exponent in the expression $Q_{pv} \sim (v/v_n)^{a_{vv}}$ was determined at the pump capacity coefficient $b_p = 1$ and the pressure increase ratio $\Delta p_{pi}/p_n = 1$.
14. In effect, the mathematical model of volumetric losses in the investigated pump takes the form (13):

$$Q_{pv} = 0.065 q_{p_{t}} n_p \left(\frac{\Delta p_{pi}}{p_n} \right)^{0.97} \left(\frac{v}{v_n} \right)^{-0.30}$$

15. Intensity Q_{pv} of pump volumetric losses described by the mathematical model (13) was compared with the results of laboratory investigations. The absolute difference between the values from the model and from the laboratory experiment did not exceed: at $b_p = 1 - +2 \div -6$ cm³s⁻¹, at $b_p = 0.227 - -8 \div -11$ cm³s⁻¹ compared with the nominal operation value of $Q_{pv} = 94$ cm³s⁻¹.
16. It must be underlined, that in the assumed conditions of determination of the k_1 coefficient (conclusion 11), the difference between the value of the intensity Q_{pv} of volumetric losses from the model and the results of laboratory investigations in nominal conditions ($b_p = 1$, $\Delta p_{pi}/p_n = 1$, $v/v_n = 1$) is equal to zero.

BIBLIOGRAPHY

1. Czyński M.: *Laboratory investigations of a hydraulic transmission energy efficiency model*. Doctor thesis. Politechnika Szczecińska, Wydział Techniki Morskiej. Szczecin 2005, promotor: Z. Paszota.
2. Paszota Z.: *Model of volumetric losses in the variable capacity displacement pump used in hydrostatic drive*. Materiały „Napędy i Sterowania’2006”. Seminarium Naukowo-Techniczne „TECHNICON’06” Gdańsk, 25.10.2006.
3. Paszota Z.: *Aspects énergétiques des transmissions hydrostatiques*. Monografia, Wydawnictwo Politechniki Gdańskiej, Gdańsk 2002. 293 s., 199 rys. bibliograf. 41 poz. Aspekty energetyczne przekładni hydrostatycznych.
4. Paszota Z.: *Model of the energy losses in the displacement rotational machines for description of efficiency of the hydrostatic drive. Part I. Model of volumetric losses*. Polish Maritime Research. 2000 vol. 7 nr 3, s. 3 – 8, 7 rys., bibliograf. 22 poz. Model strat energetycznych w maszynach wyporowych obrotowych służący opisowi sprawności napędu hydrostatycznego. Część I. Model strat objętościowych.

CONTACT WITH THE AUTHOR

Jan Koralewski, M. Sc.
Faculty of Ocean Engineering and Ship Technology
Gdansk University of Technology
Narutowicza 11/12
80-233 Gdansk, POLAND
e-mail: jkoral@pg.gda.pl
tel.: (4858) 347 29 19